

KENWOOD

# INSTRUCTION MANUAL

144 MHz FM TRANSCEIVER  
VHF FM TRANSCEIVER

## TM-271A

144 MHz FM TRANSCEIVER

## TM-271E

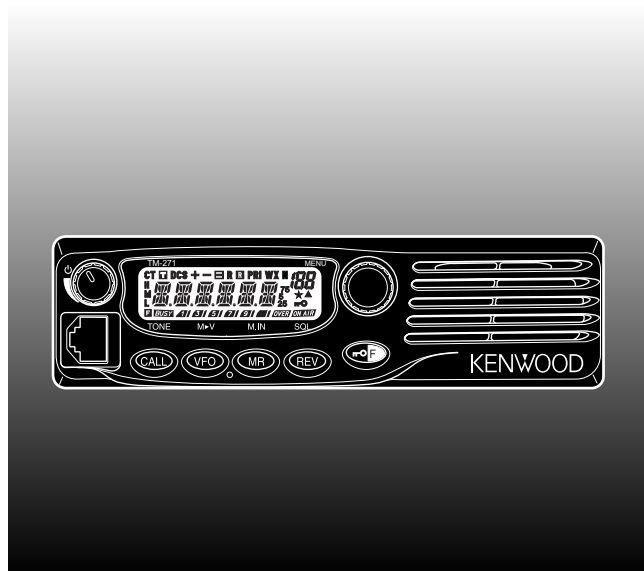

KENWOOD CORPORATION

© B62-1804-00 (K,E,M2,M3,M4)  
09 08 07 06 05 04 03 02 01 00

## THANK YOU!

Thank you for choosing this **KENWOOD** transceiver. **KENWOOD** always provides Amateur Radio products which surprise and excite serious hobbyists. This transceiver is no exception. As you learn how to use this transceiver, you will find that **KENWOOD** is pursuing “user friendliness”. For example, each time you change the Menu No. in Menu mode, you will see a text message on the display that lets you know what you are configuring.

Though user friendly, this transceiver is technically sophisticated and some features may be new to you. Consider this manual to be a personal tutorial from the designers. Allow the manual to guide you through the learning process now, then act as a reference in the coming years.

**KENWOOD** believes that this product will satisfy your requirements on both voice and data communications.

## MODELS COVERED BY THIS MANUAL

The models listed below are covered by this manual.

**TM-271A:** 144 MHz FM Transceiver

**TM-271A:** VHF FM Transceiver

**TM-271E:** 144 MHz FM Transceiver

## MARKET CODES

**K:** The Americas

**E:** Europe

**Mn:** General

(Where “n” represents a variation number.)

The market code is printed on the barcode label of the carton box.

Refer to the product specifications {pages 71, 72} for information on the available operating frequencies within each model. For accessories supplied with the model, refer to page 1.

## FEATURES

- Weather Alert Radio function checks the 1050 Hz tone from NOAA (U.S.A./ Canada only).
- Menu allows for easy control and selecting of various functions.
- Up to 200 memory channels to program frequencies and other various data. (Up to 100 memory channels if Memory Channel Names are assigned to the channels.)
- Continuous Tone Coded Squelch System (CTCSS) or Digital Code Squelch (DCS) rejects unwanted calls from other stations.
- Equipped with an easy-to-read large LCD with alphanumeric display capability.
- The dedicated DATA connector is available for 1200 bps or 9600 bps Packet operation (E market models only).
- Free PC software (Memory Control Program) is available to program the frequency, signalling, and other settings of your transceiver. The MCP can be downloaded at:  
<http://www.kenwood.com/i/products/info/amateur.html>

## NOTICES TO THE USER

One or more of the following statements may be applicable:

### FCC WARNING

This equipment generates or uses radio frequency energy. Changes or modifications to this equipment may cause harmful interference unless the modifications are expressly approved in the instruction manual. The user could lose the authority to operate this equipment if an unauthorized change or modification is made.

### INFORMATION TO THE DIGITAL DEVICE USER REQUIRED BY THE FCC

This equipment has been tested and found to comply with the limits for a Class B digital device, pursuant to Part 15 of the FCC Rules. These limits are designed to provide reasonable protection against harmful interference in a residential installation.

This equipment generates, uses and can generate radio frequency energy and, if not installed and used in accordance with the instructions, may cause harmful interference to radio communications. However, there is no guarantee that the interference will not occur in a particular installation. If this equipment does cause harmful interference to radio or television reception, which can be determined by turning the equipment off and on, the user is encouraged to try to correct the interference by one or more of the following measures:

- Reorient or relocate the receiving antenna.
- Increase the separation between the equipment and receiver.
- Connect the equipment to an outlet on a circuit different from that to which the receiver is connected.
- Consult the dealer for technical assistance.

When condensation occurs inside the transceiver:

Condensation may occur inside the transceiver when the room is warmed using a heater on a cold day or when the transceiver is quickly moved from a cold location to a warm location. When condensation occurs, the microcomputer and/or the transmit/receive circuits may become unstable, resulting in transceiver malfunction. If this happens, turn OFF the transceiver and wait for a while. When the condensed droplets disappear, the transceiver will function normally.

## PRECAUTIONS

Please observe the following precautions to prevent fire, personal injury, and/or transceiver damage:

- Do not attempt to configure your transceiver while driving; it is simply too dangerous.
- Be aware of local laws pertaining to the use of headphones/headsets while driving on public roads. If in doubt, do not wear headphones while mobiling.
- Do not transmit with high output power for extended periods; the transceiver may overheat.
- Do not modify the transceiver unless instructed by this manual or other **KENWOOD** documentation.
- Do not expose the transceiver to long periods of direct sunlight nor place it close to heating appliances.
- Do not place the transceiver in excessively dusty, humid or wet areas, nor on unstable surfaces.
- If an abnormal odor or smoke is detected coming from the transceiver, turn OFF the power immediately. Contact a **KENWOOD** service station or your dealer.
- This transceiver is designed for a 13.8 V power source. Never use a 24 V battery to power the transceiver.

# CONTENTS

SUPPLIED ACCESSORIES .....	1	SELECTING A FREQUENCY .....	15
WRITING CONVENTIONS FOLLOWED IN THIS MANUAL .....	1	VFO MODE .....	15
<b>CHAPTER 1 PREPARATION</b>		MHZ MODE .....	16
MOBILE INSTALLATION .....	2	DIRECT FREQUENCY ENTRY .....	16
DC POWER CABLE CONNECTION .....	3	<b>CHAPTER 5 MENU SETUP</b>	
Mobile Operation .....	3	WHAT IS A MENU? .....	18
Fixed Station Operation .....	4	MENU ACCESS .....	18
Replacing Fuses .....	5	MENU FUNCTION LIST .....	19
ANTENNA CONNECTION .....	5	<b>CHAPTER 6 OPERATING THROUGH REPEATERS</b>	
ACCESSORY CONNECTIONS .....	6	OFFSET PROGRAMMING FLOW .....	22
External Speaker .....	6	PROGRAMMING AN OFFSET .....	23
Microphone .....	6	SELECTING AN OFFSET DIRECTION .....	23
PC Connection .....	6	SELECTING AN OFFSET FREQUENCY .....	23
CONNECTING TO A TNC (E MARKET MODELS ONLY) ....	7	ACTIVATING THE TONE FUNCTION .....	24
<b>CHAPTER 2 YOUR FIRST QSO</b>		SELECTING A TONE FREQUENCY .....	24
<b>CHAPTER 3 GETTING ACQUAINTED</b>		AUTOMATIC REPEATER OFFSET .....	25
FRONT PANEL .....	9	TRANSMITTING A 1750 Hz TONE .....	25
DISPLAY .....	10	REVERSE FUNCTION .....	26
REAR PANEL .....	12	AUTOMATIC SIMPLEX CHECK (ASC) .....	26
MICROPHONE .....	12	TONE FREQUENCY ID SCAN .....	27
Mic Keypad Direct Entry .....	13	<b>CHAPTER 7 MEMORY CHANNELS</b>	
<b>CHAPTER 4 OPERATING BASICS</b>		NUMBER OF MEMORY CHANNELS .....	28
SWITCHING THE POWER ON/OFF .....	14	SIMPLEX & REPEATER OR ODD-SPLIT MEMORY CHANNEL? .....	28
ADJUSTING THE VOLUME .....	14	STORING SIMPLEX FREQUENCIES OR STANDARD REPEATER FREQUENCIES .....	29
ADJUSTING THE SQUELCH .....	14	STORING ODD-SPLIT REPEATER FREQUENCIES .....	30
TRANSMITTING .....	15		
SELECTING AN OUTPUT POWER .....	15		

RECALLING A MEMORY CHANNEL .....	30
USING THE TUNING CONTROL .....	30
USING THE MICROPHONE KEYPAD .....	31
CLEARING A MEMORY CHANNEL .....	31
NAMING A MEMORY CHANNEL .....	32
MEMORY CHANNEL TRANSFER .....	33
MEMORY → VFO TRANSFER .....	33
CHANNEL → CHANNEL TRANSFER .....	33
CALL CHANNEL .....	35
RECALLING THE CALL CHANNEL .....	35
REPROGRAMMING THE CALL CHANNEL .....	35
WEATHER ALERT (K MARKET MODELS ONLY) .....	36
PROGRAMMING THE WEATHER RADIO FREQUENCY .....	36
ENABLING A WEATHER ALERT .....	36
CHANNEL DISPLAY .....	37
<b>CHAPTER 8 SCAN</b>	
NORMAL SCAN .....	40
BAND SCAN .....	40
PROGRAM SCAN .....	40
MHZ SCAN .....	41
MEMORY SCAN .....	42
ALL-CHANNEL SCAN .....	42
GROUP SCAN .....	42
CALL SCAN .....	43
PRIORITY SCAN .....	43
PROGRAMMING A PRIORITY CHANNEL .....	43
USING PRIORITY SCAN .....	44
MEMORY CHANNEL LOCKOUT .....	44

SCAN RESUME METHOD .....	45
<b>CHAPTER 9 SELECTIVE CALL</b>	
CTCSS AND DCS .....	46
CTCSS .....	46
SELECTING A CTCSS FREQUENCY .....	47
CTCSS FREQUENCY ID SCAN .....	47
DCS .....	48
SELECTING A DCS CODE .....	48
DCS CODE ID SCAN .....	49
<b>CHAPTER 10 DUAL TONE MULTI-FREQUENCY (DTMF) FUNCTIONS</b>	
MANUAL DIALING .....	50
DTMF MONITOR .....	50
DTMF TX HOLD .....	51
AUTOMATIC DIALER .....	51
STORING A DTMF NUMBER IN MEMORY .....	51
CONFIRMING STORED DTMF NUMBERS .....	52
TRANSMITTING A STORED DTMF NUMBER .....	52
ADJUSTING THE DTMF TONE TRANSMISSION SPEED .....	52
ADJUSTING THE PAUSE DURATION .....	53
DTMF LOCK .....	53
<b>CHAPTER 11 AUXILIARY FUNCTIONS</b>	
APO (AUTO POWER OFF) .....	54
BEAT SHIFT .....	54
S-METER SQUELCH .....	54
SQUELCH HANG TIME .....	55
BEEP FUNCTION .....	55
BUSY CHANNEL LOCKOUT .....	56

- 1
- 2
- 3
- 4
- 5
- 6
- 7
- 8
- 9
- 10
- 11
- 12
- 13
- 14

FREQUENCY STEP SIZE .....	56
DISPLAY BACKLIGHT .....	57
PERMANENT BACKLIGHT .....	57
AUTOMATIC BACKLIGHT .....	57
LOCK FUNCTION .....	58
DATA COMMUNICATION SPEED .....	58
TUNE ENABLE .....	58
MICROPHONE PF KEYS (KEYPAD MODELS ONLY) .....	59
NARROW BAND FM OPERATION .....	60
POWER-ON MESSAGE .....	60
PROGRAMMABLE VFO .....	61
TIME-OUT TIMER .....	62
<b>CHAPTER 12</b> MICROPHONE CONTROL	
MIC LOCK .....	64
<b>CHAPTER 13</b> OPTIONAL ACCESSORIES	
<b>CHAPTER 14</b> TROUBLESHOOTING	
MAINTENANCE .....	66
GENERAL INFORMATION .....	66
SERVICE .....	66
SERVICE NOTE .....	66
CLEANING .....	67
RESETTING THE TRANSCEIVER .....	67
INITIAL SETTINGS .....	67
FULL RESET .....	67
VFO RESET .....	68
TROUBLESHOOTING .....	69
<b>SPECIFICATIONS</b>	
<b>INDEX</b>	

## SUPPLIED ACCESSORIES

After carefully unpacking the transceiver, identify the items listed in the table below. We recommend you keep the box and packaging for shipping.

A market area code (K, E, M2, M3, or M4) can be found on the label attached to the package box.

Accessory		Part Number	Qty
Microphone	M2, M4 market (KMC-30)	T91-0624-XX	1
	K, E, M3 market (DTMF Mic)	T91-0641-XX	
DC power cable	K, M2, M3, M4 market	E30-2111-XX	1
	E market	E30-3452-XX	
Fuse	K, M2, M3, M4 market	F51-0017-XX	1
	E market	F52-0024-XX	
Mounting bracket		J29-0662-XX	1
Microphone hanger		J19-1584-XX	1
Screw set		N99-0395-XX	1
Warranty card (K, E market only)		—	1
Instruction manual		B62-1804-XX	1

## WRITING CONVENTIONS FOLLOWED IN THIS MANUAL

The writing conventions described below have been followed to simplify instructions and avoid unnecessary repetition.

Instruction	What to do
Press <b>[KEY]</b> .	Press and release <b>KEY</b> .
Press <b>[KEY] (1s)</b> .	Press and hold <b>KEY</b> for 1 second or longer.
Press <b>[KEY1], [KEY2]</b> .	Press <b>KEY1</b> momentarily, release <b>KEY1</b> , then press <b>KEY2</b> .
Press <b>[KEY1]+[KEY2]</b> .	Press and hold <b>KEY1</b> , then press <b>KEY2</b> . If there are more than 2 keys, press and hold each key in turn until the final key has been pressed.
Press <b>[KEY]+[⏻]</b> .	With the transceiver power OFF, press and hold <b>KEY</b> , then turn the transceiver power ON by pressing <b>[⏻]</b> (Power Switch).

# PREPARATION

## 1 MOBILE INSTALLATION

To install the transceiver, select a safe, convenient location inside your vehicle that minimizes danger to your passengers and yourself while the vehicle is in motion. Consider installing the unit at an appropriate position so that knees or legs will not strike it during sudden braking of your vehicle. Try to pick a well ventilated location that is shielded from direct sunlight.

1 Install the mounting bracket in the vehicle using the supplied self-tapping screws (4), flat washers (4), and spring washers (4).

- The bracket must be installed so that the 3 screw hole positions on the side of the mounting bracket are towards the rear of the bracket.

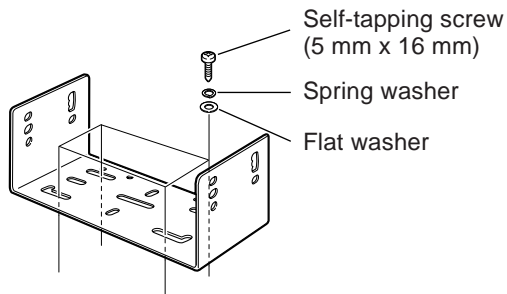

2 Position the transceiver, then insert and tighten the supplied hexagon SEMS screws (4) and flat washers (4).

- Double check that all hardware is tightened to prevent vehicle vibration from loosening the bracket or transceiver.

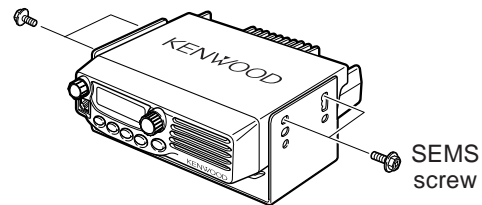

- Determine the appropriate angle of the transceiver, using the 3 screw hole positions on the side of the mounting bracket.

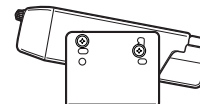
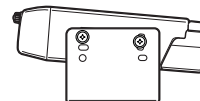
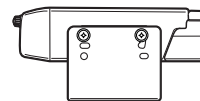



## DC POWER CABLE CONNECTION



CAUTION

Locate the power input connector as close to the transceiver as possible.

### MOBILE OPERATION

The vehicle battery must have a nominal rating of 12 V. Never connect the transceiver to a 24 V battery. Be sure to use a 12 V vehicle battery that has sufficient current capacity. If the current to the transceiver is insufficient, the display may darken during transmission, or transmit output power may drop excessively.

- 1 Route the DC power cable supplied with the transceiver directly to the vehicle's battery terminals using the shortest path from the transceiver.
  - If using a noise filter, it should be installed with an insulator to prevent it from touching metal on the vehicle.
  - We recommend you do not use the cigarette lighter socket as some cigarette lighter sockets introduce an unacceptable voltage drop.
  - The entire length of the cable must be dressed so it is isolated from heat, moisture, and the engine secondary (high voltage) ignition system/ cables.
- 2 After the cable is in place, wrap heat-resistant tape around the fuse holder to protect it from moisture and tie down the full run of cable.
- 3 To prevent the risk of short circuits, disconnect other wiring from the negative (-) battery terminal before connecting the transceiver.

- 4 Confirm the correct polarity of the connections, then attach the power cable to the battery terminals; red connects to the positive (+) terminal and black connects to the negative (-) terminal.
  - Use the full length of the cable without cutting off excess even if the cable is longer than required. In particular, never remove the fuse holders from the cable.

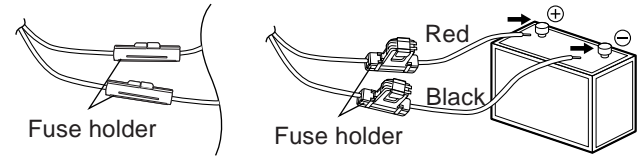

- 5 Reconnect any wiring removed from the negative terminal.
- 6 Connect the DC power cable to the transceiver's power supply connector.
  - Press the connectors firmly together until the locking tab clicks.

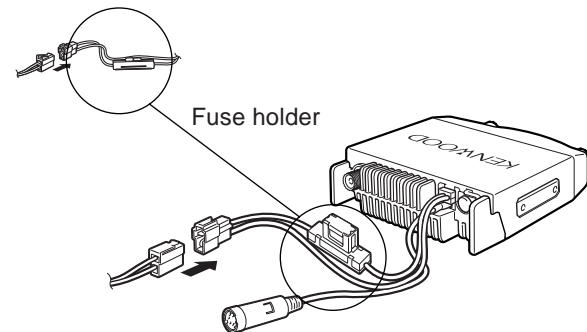

1

## FIXED STATION OPERATION

**1** In order to use this transceiver for fixed station operation, you will need a separate 13.8 V DC power supply (not included). The recommended current capacity of your power supply is 12 A.

- 1 Connect the DC power cable to the regulated DC power supply and ensure that the polarities are correct (Red: positive, Black: negative).
  - Do not directly connect the transceiver to an AC outlet.
  - Use the supplied DC power cable to connect the transceiver to a regulated power supply.
  - Do not substitute a cable with smaller gauge wires.

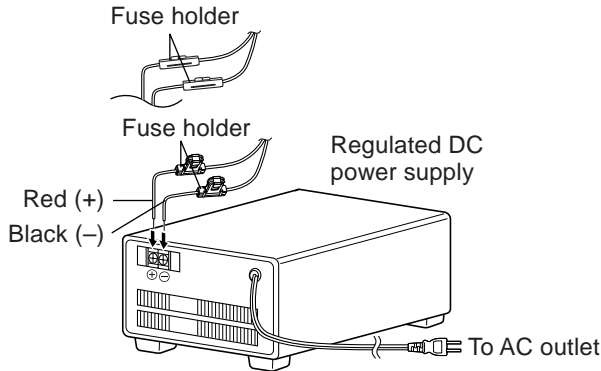

- 2 Connect the transceiver's DC power connector to the connector on the DC power cable.
  - Press the connectors firmly together until the locking tab clicks.

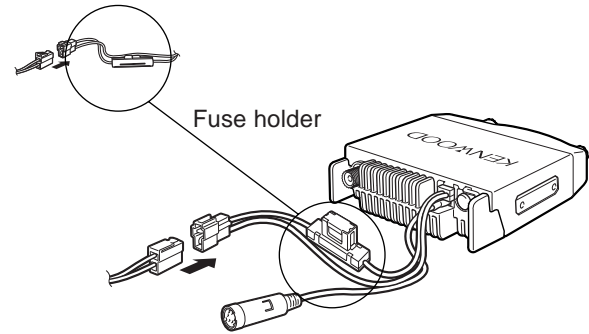

---

### Note:

- ◆ For your transceiver to fully exhibit its performance capabilities, we recommend using the optional PS-33 (20.5 A, 25% duty cycle) power supply.
  - ◆ Before connecting the DC power supply to the transceiver, be sure to switch the transceiver and the DC power supply OFF.
  - ◆ Do not plug the DC power supply into an AC outlet until you make all connections.
-

## REPLACING FUSES

If the fuse blows, determine the cause, then correct the problem. After the problem is resolved, replace the fuse. If newly installed fuses continue to blow, disconnect the power cable and contact your authorized **KENWOOD** dealer or an authorized **KENWOOD** service center for assistance.

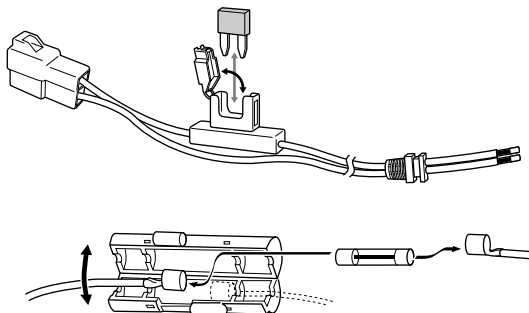

Fuse Location	Fuse Current Rating
Transceiver	15 A
Supplied Accessory DC Power Cable	20 A



Only use fuses of the specified type and rating; otherwise the transceiver could be damaged.

**Note:** If you use the transceiver for a long period when the vehicle battery is not fully charged, or when the engine is OFF, the battery may become discharged, and will not have sufficient reserves to start the vehicle. Avoid using the transceiver under these conditions.

## ANTENNA CONNECTION

Before operating, install an efficient, well-tuned antenna. The success of your installation will depend largely on the type of antenna and its correct installation. The transceiver can give excellent results if the antenna system and its installation are given careful attention.

Use a 50  $\Omega$  impedance antenna and low-loss coaxial feed line that has a characteristic impedance of 50  $\Omega$ , to match the transceiver input impedance. Coupling the antenna to the transceiver via feed lines having an impedance other than 50  $\Omega$  reduces the efficiency of the antenna system and can cause interference to nearby broadcast television receivers, radio receivers, and other electronic equipment.

**Note:** E market models use an N-type antenna connector while other models use an M-type (SO-239) connector.



- ◆ Transmitting without first connecting an antenna or other matched load may damage the transceiver. Always connect the antenna to the transceiver before transmitting.
- ◆ All fixed stations should be equipped with a lightning arrester to reduce the risk of fire, electric shock, and transceiver damage.

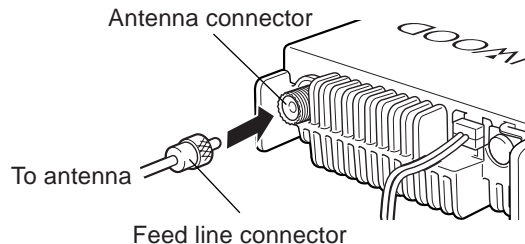

## ACCESSORY CONNECTIONS

1

### EXTERNAL SPEAKER

If you plan to use an external speaker, choose a speaker with an impedance of  $8\ \Omega$ . The external speaker jack accepts a 3.5 mm (1/8") mono (2-conductor) plug. We recommend using the SP-50B speaker.

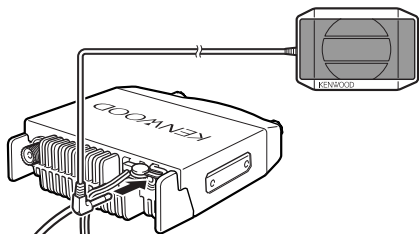

### MICROPHONE

For voice communications, connect a 600  $\Omega$  microphone equipped with an 8-pin modular plug into the modular socket on the front of the main unit. Press firmly on the plug until the locking tab clicks.

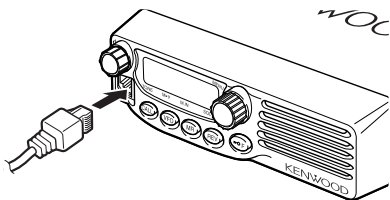

Attach the supplied microphone hanger in an appropriate location using the screws included in the screw set.

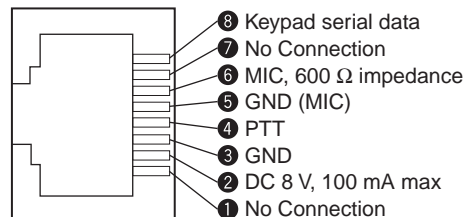
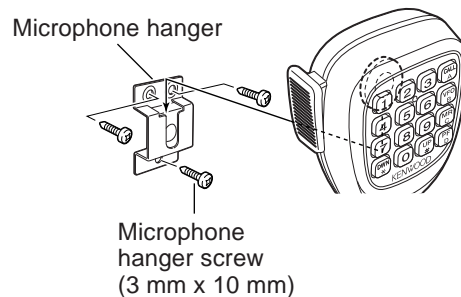

### PC CONNECTION

To utilize the optional MCP-1A software, you must first connect the transceiver to your PC using an optional Programming Cable (via the microphone jack).

The MCP-1A is free downloadable software available from **KENWOOD** at the following URL:

<http://www.kenwood.com/i/products/info/amateur.html>

---

**Note:** Ask your dealer about purchasing a Programming Cable.

---

## CONNECTING TO A TNC (E MARKET MODELS ONLY)

To connect an external TNC to the transceiver, use an optional PG-5A cable. The DATA connector on the rear of the transceiver mates with the 6-pin mini-DIN plug on this cable.

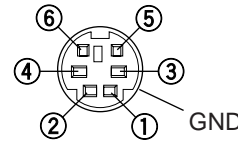

1

Pin No.	Pin Name	Function
1	PKD	Packet data input <ul style="list-style-type: none"> <li>TX data from TNC to transceiver</li> </ul>
2	GND	Ground for PKD
3	PKS	Packet standby <ul style="list-style-type: none"> <li>TNC can use this pin to inhibit the transceiver microphone input while transmitting packet signals.</li> </ul>
4	PR9	Output of detected 9600 bps data (500 mV <sub>P-P</sub> , 10 kΩ) <ul style="list-style-type: none"> <li>Also functions as a common pin for 1200 bps and 9600 bps data output.</li> </ul>
5	PR1	Output of detected 1200 bps data (500 mV <sub>P-P</sub> , 10 kΩ)
6	SQC	Squelch control output <ul style="list-style-type: none"> <li>Inhibits TNC data transmitting while transceiver squelch is open.</li> <li>Prevents interference to voice communications on the same frequency. Also prevents retries.</li> <li>Output Level               <ul style="list-style-type: none"> <li>Open squelch: +5 V (High)</li> <li>Closed squelch: 0 V (Low)</li> </ul> </li> </ul>

### Note:

- ◆ If the external TNC has a common pin for 1200 bps and 9600 bps data output, connect this pin to the DATA connector PR9 pin. Shorting the PR9 and PR1 pins will cause the TNC to malfunction.
- ◆ Adjust the transceiver data communication speed (1200 bps or 9600 bps) as necessary {page 58}.
- ◆ If DC voltage is input to the PR1 pin, the external TNC may not function. If this problem happens, add a 10 μF capacitor between the PR1 pin and the TNC. Be careful with the polarity of the capacitor.

# YOUR FIRST QSO

2

Are you ready to give your transceiver a quick try? Reading this section should get your voice on the air right away. The instructions below are intended only as a quick guide. If you encounter problems or there is something you would like to know more, read the detailed explanations given later in this manual.

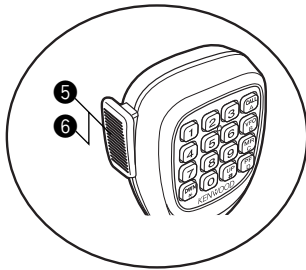
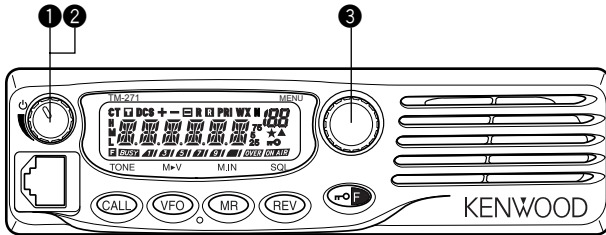

- 1 Press [  ] (Power) briefly to switch the transceiver power ON.
  - A high pitched double beep sounds and a Power-on message appears momentarily. The various indicators and the current operating frequency appear on the LCD.
  - The transceiver stores the current parameters when it is turned OFF and automatically recalls those parameters the next time you turn the transceiver ON.
- 2 Turn the **Volume** control clockwise, to the 9 o'clock position.
- 3 Turn the **Tuning** control to select a reception frequency.
  - You may further turn the **Volume** control to adjust the volume level of the signal.
- 4 To transmit, hold the microphone approximately 5 cm (2 inches) from your mouth.
- 5 Press and hold Mic [PTT], then speak in your normal tone of voice.
- 6 Release Mic [PTT] to receive.
- 7 Repeat steps 4, 5, and 6 to continue communication.

# GETTING ACQUAINTED

## FRONT PANEL

**Note:** This section describes only the main functions of the front panel controls. Explanations for functions not described here are provided in the appropriate sections of this instruction manual.

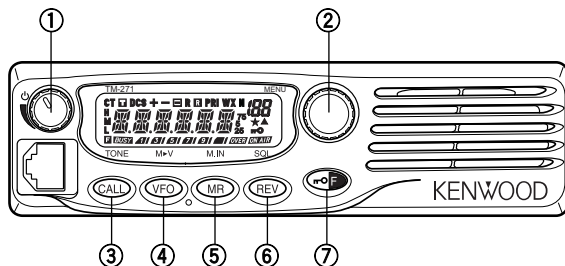

### ① ⏻ (Power) switch/ Volume control

Press to switch the transceiver power ON or OFF {page 14}.

Turn to adjust the level of the receive audio from the speaker {page 14}.

### ② MENU button/ Tuning control

Press to enter MHz Mode {page 16}. In this mode, you can change the operating frequency in 1 MHz steps using the **Tuning** control or Mic **[UP]/[DWN]**. Press and hold for 1 second while in VFO Mode to begin MHz Scan {page 41} or while in MR Mode to begin Group Scan {page 42}.

Press **[F]** then press **[MENU]** to enter Menu Mode {page 18}.

Turn to select:

- Operating frequencies when in VFO Mode {page 15}.
- Memory Channels when in Memory Recall Mode {page 30}.
- Menu Nos. when in Menu Mode {page 18}.
- Scan direction while scanning {pages 27, 39, 47, 49}.

### ③ CALL key

Press to recall the Call Channel {page 35}. Press and hold for 1 second while in VFO Mode to begin Call/VFO Scan {page 43}. Press and hold for 1 second while in Memory Recall Mode to begin Call/Memory Scan {page 43}.

Press **[F]** then press **[CALL]** to activate the Tone {page 24}, CTCSS {page 46}, or DCS {page 48} function.

### ④ VFO key

Press to enter VFO Mode {page 15}. In this mode, you can change the operating frequency using the **Tuning** control or Mic **[UP]/[DWN]**. Press and hold for 1 second while in VFO Mode to begin Band Scan {page 40}. Press and hold for 1 second while in VFO Mode after programming a scan range to begin Program Scan {page 40}.

In MR Mode, press **[F]** then press **[VFO]** to transfer the contents of the selected Memory Channel to the VFO {page 33}.

### ⑤ MR key

Press to enter Memory Recall Mode {page 30}. In this mode, you can change memory channels using the **Tuning** control or Mic **[UP]/[DWN]**. Press and hold for 1 second while in Memory Recall Mode to begin Memory Scan {page 42}.

Press **[F]**, use the **Tuning** control to select the desired channel, then press **[MR]** to reprogram the Call Channel or a Memory Channel {page 29}.

### ⑥ REV key

Press to switch the transmit frequency and receive frequency when operating with an offset {page 23} or an odd-split Memory Channel {page 28}.

Press **[F]** then press **[REV]** and rotate the **Tuning** control to increase or decrease the squelch level {page 14}.

### ⑦ $\pi$ -O/F key

Press and hold for 1 second to lock the transceiver keys {page 58}.

Press momentarily to access the second functions of the transceiver keys.

## DISPLAY

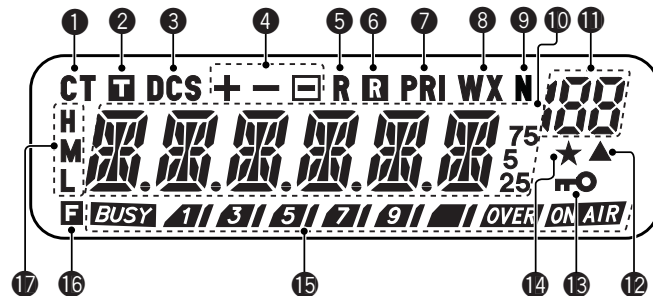

### ① CT

Appears when the CTCSS function is activated {page 46}.

### ② □

Appears when the Tone function is activated {page 24}.

### ③ DCS

Appears when the DCS function is activated {page 48}.

### ④ + - □

Appears when the repeater shift function is activated {pages 23, 30}. (“□” is not used on this transceiver.)

### ⑤ R

Appears when the Reverse function is activated {page 26}.



## 6 R

Appears when the Automatic Simplex Check (ASC) function is activated {page 26}.

## 7 PRI

Appears when the Priority Scan function is activated {page 43}.

## 8 WX

Appears when the Weather Alert function is activated {page 36}. (K market models only.)

## 9 N

Appears when narrow FM Mode is selected {page 60}.

## 10

Displays the frequencies, Menu settings, Memory name and other information.

## 11

Displays the Menu No., Memory Channel number, and status {pages 18, 29}.

## 12 ▲

Appears when the displayed Memory Channel has data {page 29}.

## 13

Appears when the Key Lock function is ON {page 58}.

## 14 ★

Appears when the Memory Channel Lockout function is ON {page 44}.

## 15

Shows the strength of transmitted {page 15} and received {page 54} signals.

**BUSY** indicates the squelch is open and the frequency is “busy”. It also appears when the squelch is set to minimum {page 14}. If using CTCSS or DCS, it indicates the squelch is open due to a received signal that contains the same CTCSS tone or DCS code that is set in your transceiver.

**1 3 5 7 9** acts as an S-meter while receiving and an RF power meter while transmitting.

**ON AIR** indicates the transceiver is transmitting.

## 16 F

Appears when the function key is pressed.

## 17

H appears when high power transmission is selected and L appears when low power is selected {page 15}. (“M” is not used on this transceiver.)

## REAR PANEL

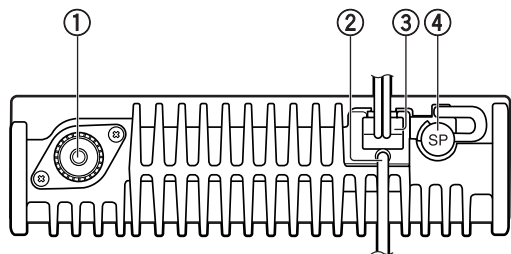

3

### ① Antenna connector

Connect an external antenna {page 5} here. When making test transmissions, connect a dummy load in place of the antenna. The antenna system or load should have an impedance of 50  $\Omega$ .

---

**Note:** E market models use an N-type antenna connector while other models use an M-type (SO-239) connector.

---

### ② Data cable (E market versions only)

Connect this cable to a TNC {page 7}.

### ③ Power Input 13.8 V DC cable

Connect a 13.8 V DC power source here. Use the supplied DC power cable {pages 3, 4}.

### ④ SP (speaker) jack

If desired, connect an optional external speaker for clearer audio. This jack accepts a 3.5 mm (1/8") mono (2-conductor) plug. See page 6.

## MICROPHONE

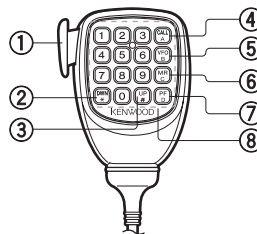

DTMF Microphone

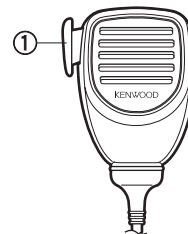

Microphone (KMC-30)

### ① PTT (Push-to-Talk) switch

Press and hold to transmit. Release to receive.

### ② DWN/ \* key

Press to lower the operating frequency, Memory Channel number, Menu Number, etc. Hold down to repeat the action. Also press to switch between values for functions with multiple choices. Press and hold Mic [PTT], then press [DWN/ \*] to transmit \*.

### ③ UP/ # key

Press to raise the operating frequency, Memory Channel number, Menu Number, etc. Hold down to repeat the action. Also press to switch between values for functions with multiple choices. Press and hold Mic [PTT], then press [UP/ #] to transmit #.

#### ④ CALL/A key

Identical to the front panel **CALL** key. This key can be reprogrammed if desired {page 59}. Press and hold Mic **[PTT]**, then press **[CALL/A]** to transmit A.

#### ⑤ VFO/B key

Identical to the front panel **VFO** key. This key can be reprogrammed if desired {page 59}. Press and hold Mic **[PTT]**, then press **[VFO/B]** to transmit B.

#### ⑥ MR/C key

Identical to the front panel **MR** key. This key can be reprogrammed if desired {page 59}. Press and hold Mic **[PTT]**, then press **[MR/C]** to transmit C.

#### ⑦ PF/D key

The default function of this key is 1 MHz step. This key can be reprogrammed if desired {page 59}. Press and hold Mic **[PTT]**, then press **[PF/D]** to transmit D.

#### ⑧ DTMF keypad

This 16-key keypad is used for DTMF functions {page 50} or to directly enter an operating frequency {page 16}, or a Memory Channel number {page 30}. The keypad can also be used to program a Memory Channel name, Power-on message, or other character strings {page 63}.

### Mic KEYPAD DIRECT ENTRY

The microphone keypad (keypad models only) allows you to make various entries depending on which mode the transceiver is in.

In VFO or Memory Recall mode, use the Mic keypad to select a frequency {page 16} or Memory Channel number {page 30}. First press the Mic PF key assigned the ENTER function {page 59}.

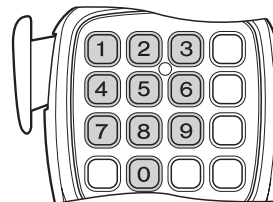

To manually send a DTMF number, press and hold Mic **[PTT]**, then press the DTMF keys on the Mic keypad {page 50} in sequence.



You can also use the Mic keypad to program a Memory Channel name, Power-on message, or other character strings {page 63}.

## SWITCHING THE POWER ON/OFF

- 1 Press [  ] (Power) to switch the transceiver power ON.
  - A high pitched double beep sounds and a Power-on message {page 60} appears briefly, followed by the frequency and other indicators.

4



- 2 To switch the transceiver OFF, press [  ] (Power) (1s).
  - When you turn the transceiver OFF, a low pitched double beep sounds.
  - The transceiver stores the current frequency and parameters when it is turned OFF and recalls these parameters the next time you turn the transceiver ON.

## ADJUSTING THE VOLUME

Turn the **Volume** control clockwise to increase the audio output level and counterclockwise to decrease the output level.

- If you are not receiving a signal, press the Mic PF key assigned the MONI function {page 59}, then adjust the **Volume** control to a comfortable audio output level. Press the MONI key again to cancel the Monitor function.

## ADJUSTING THE SQUELCH

The purpose of Squelch is to mute the speaker when no signals are present. With the squelch level correctly set, you will hear sound only while actually receiving signals. The higher the selected squelch level, the stronger the signals must be to receive. The appropriate squelch level depends on the ambient RF noise conditions.

- 1 Press [F], [REV].
  - The current squelch level appears.



- 2 Turn the **Tuning** control to adjust the level.
  - Select the level at which the background noise is just eliminated when no signal is present.
  - The higher the level, the stronger the signals must be to receive.
  - 10 different levels can be set.  
(0: Minimum ~ 9: Maximum; 1 is the default value)
- 3 Press any key other than [  ] (Power) to store the new setting and exit the squelch adjustment.

## TRANSMITTING

- 1 To transmit, hold the microphone approximately 5 cm (2 inches) from your mouth, then press and hold Mic **[PTT]** and speak into the microphone in your normal tone of voice.
  - “**ON AIR**” and the RF Power meter appears. The RF Power meter shows the relative transmit output power (**1 3 5 7 9** **OVER**).
  - If you press Mic **[PTT]** while you are outside the transmission coverage, a high pitched error beep sounds.
- 2 When you finish speaking, release Mic **[PTT]**.

---

**Note:** If you continuously transmit for longer than the time specified in Menu No. 21 (default is 10 minutes) {page 62}, the internal time-out timer generates a warning beep and the transceiver stops transmitting. In this case, release Mic **[PTT]** and let the transceiver cool down for a while, then press Mic **[PTT]** again to resume transmission.

---

## SELECTING AN OUTPUT POWER

---

**M4 market version only:** The output power of M4 market models cannot be adjusted. It is fixed at 25 W.

---

You can configure different power levels for transmission.

- 1 Press **[F]**, **[MENU]** and turn the **Tuning** control to select Menu No. 6 (TXP).



- 2 Press **[MENU]** and turn the **Tuning** control to select “H” (high; default) or “L” (low) power.
- 3 Press **[MENU]** to store the setting or any other key to cancel.
- 4 Press any key other than **[MENU]** to exit Menu Mode.



### CAUTION

- ◆ Do not transmit at high output power for an extended period of time. The transceiver could overheat and malfunction.
- ◆ Continuous transmission causes the heat sink to overheat. Never touch the heat sink when it may be hot.

---

**Note:** When the transceiver overheats because of ambient high temperature or continuous transmission, the protective circuit may function to lower transmit output power.

---

## SELECTING A FREQUENCY

### VFO MODE

This is the basic mode for changing the operating frequency. To enter VFO Mode, press **[VFO]**.

Turn the **Tuning** control clockwise to increase the frequency and counterclockwise to decrease the frequency, or use Mic **[UP]/[DWN]**.



- Press and hold Mic **[UP]/[DWN]** to step the frequency repeatedly.

## MHz Mode

If the desired operating frequency is far away from the current frequency, it is quicker to use the MHz Tuning Mode.

To adjust the MHz digit:

- 1 While in VFO or Call Mode, press **[MENU]**.
  - The MHz digit blinks.

4



- 2 Turn the **Tuning** control to select the desired MHz value.
- 3 Press any key to set the selected frequency and return to normal VFO Mode.
- 4 Continue adjusting the frequency as necessary, using the **Tuning** control or Mic **[UP]/[DWN]**.

## DIRECT FREQUENCY ENTRY

In addition to turning the **Tuning** control or pressing Mic **[UP]/[DWN]**, there is another way to select the frequency. When the desired frequency is far away from the current frequency, you can directly enter a frequency using the Mic keypad (keypad models only).

- 1 Press **[VFO]**.
  - You must be in VFO mode to make a direct frequency entry.
- 2 Press the Mic PF key assigned the ENTER function {page 59}.



- 3 Press the numeric keys (**[0]** to **[9]**) to enter your desired frequency.
  - Pressing Mic **Enter** fills all remaining digits (the digits you did not enter) with 0 and completes the entry. For example, to select 145.000 MHz, press **[1]**, **[4]**, **[5]** and press Mic **Enter** to complete the entry.
  - If you want to revise the MHz digits only, leaving the kHz digits as they are, press Mic **[VFO]** in place of Mic **Enter**.

### Example 1

To enter 145.750 MHz:

Key in	Display
[Enter]	--- ---
[1], [4], [5]	1 4 5. ---
[7], [5], [0]	1 4 5. 7 5 0

### Example 2

To enter 145.000 MHz:

Key in	Display
[Enter]	--- ---
[1], [4], [5]	1 4 5. ---
[Enter]	1 4 5. 0 0 0

### Example 3

To change 144.650 MHz to 145.650 MHz:

Key in	Display
	1 4 4. 6 5 0
[Enter]	--- ---
[1], [4], [5]	1 4 5. ---
Mic [VFO]	1 4 5. 6 5 0

---

**Note:** If the entered frequency does not match the current frequency step size, the frequency is automatically rounded down to the next available frequency. When the desired frequency cannot be entered exactly, confirm the frequency step size (page 56).

---

# MENU SETUP

## WHAT IS A MENU?

Many functions on this transceiver are selected or configured via a software-controlled Menu rather than through the physical controls of the transceiver. Once you become familiar with the Menu system, you will appreciate its versatility. You can customize the various timings, settings, and programming functions on this transceiver to meet your needs without using many controls and switches.

5

## MENU ACCESS

1 Press **[F]**, **[MENU]**.

- A brief explanation of the menu, and the setting and Menu No. appear on the display.



- 2 Turn the **Tuning** control to select your desired Menu.
- As you change the Menu No., a brief explanation of each menu appears along with its current parameter.



- 3 Press **[MENU]** to configure the parameter of the currently selected Menu No.



- 4 Turn the **Tuning** control to select your desired parameter.



- 5 Press **[MENU]** to store the new setting or any other key to cancel.
- 6 Press any key other than **[MENU]** to exit Menu Mode.



## MENU FUNCTION LIST

On the display	Menu No.	Function	Selections	Default	Ref. Page
STP	1	Frequency step size	2.5/ 5/ 6.25/ 10/ 12.5/ 15/ 20/ 25/ 30/ 50/ 100 kHz	Varies (see reference page)	56
T	2	Tone frequency	67.0 ~ 254.1 Hz	88.5	24
CT	3	CTCSS frequency	67.0 ~ 254.1 Hz	88.5	47
DCS	4	DCS code	023 ~ 754	023	48
SFT	5	Shift direction	OFF/ +/ –	OFF	23
TXP <sup>1</sup>	6	Transmission power	High/ Low	High	15
P.VFO	7	Programmable VFO	136 ~ 173 MHz	136 ~ 173 MHz	61
SSQ	8	S-Meter squelch	ON/ OFF	OFF	54
SQH	9	Squelch hang time	OFF/ 125/ 250/ 500 ms	OFF	55
OFFSET	10	Repeater offset frequency	0 ~ 69.95 MHz	600 kHz	23
ARO	11	Automatic Repeater Offset	ON/ OFF	Varies (see reference page)	25
PRI	12	Priority Scan	ON/ OFF	OFF	43
SCAN	13	Scan Resume method	TO/ CO/ SE	TO	45
L.OUT	14	Memory Channel Lockout	ON/ OFF	OFF	44
M.CH	15	Memory Channel capacity	100/ 200	100	28
M.NAME	16	Memory Name	6 characters	–	32
MDF	17	Memory Name/ Frequency display	MN/ FRQ	MN	32
APO	18	Automatic Power-off	OFF/ 30/ 60/ 90/ 120/ 180 min.	OFF	54

On the display	Menu No.	Function	Selections	Default	Ref. Page
CK	19	CALL key	CALL/ 1750	Varies (see reference page)	25,35
HLD	20	1750 Hz tone TX hold	ON/ OFF	OFF	25
TOT	21	Time-out Timer	3/ 5/ 10 min.	10	62
BCL	22	Busy Channel Lockout	ON/ OFF	OFF	56
P.ON.MSG	23	Power-on message	6 characters	–	60
BP	24	Beep	ON/ OFF	ON	55
BS	25	Beat Shift	ON/ OFF	OFF	54
FMN	26	Narrow FM	ON/ OFF	OFF	60
ENC	27	Tuning control lock	ON/ OFF	OFF	58
DTMF.MR	28	Automatic dialer	Up to 16 digits	–	51
SPD	29	DTMF TX speed	FA/ SL	FA	52
DT.H	30	DTMF TX hold	ON/ OFF	OFF	51
PA	31	DTMF pause period	100/ 250/ 500/ 750/ 1000/ 1500/ 2000 ms	500	53
DT.L	32	DTMF key lock	ON/ OFF	OFF	53
DT.M	33	DTMF monitor	ON/ OFF	OFF	50
MC.L	34	Microphone key lock	ON/ OFF	OFF	64
PF 1	35	Microphone programmable function key	MONI/ ENTER/ 1750/ VFO/ MR/ CALL/ MHZ/ REV/ SQL/ M--V/ M.IN/ C.IN/ MENU/ SHIFT/ LOW/ BRIGHT/ LOCK/ TONE/ STEP	MHZ	59

On the display	Menu No.	Function	Selections	Default	Ref. Page
PF 2	36	Microphone programmable function key	MONI/ ENTER/ 1750/ VFO/ MR/ CALL/ MHZ/ REV/ SQL/ M--V/ M.IN/ C.IN/ MENU/ SHIFT/ LOW/ BRIGHT/ LOCK/ TONE/ STEP	MR	59
PF 3	37	Microphone programmable function key	MONI/ ENTER/ 1750/ VFO/ MR/ CALL/ MHZ/ REV/ SQL/ M--V/ M.IN/ C.IN/ MENU/ SHIFT/ LOW/ BRIGHT/ LOCK/ TONE/ STEP	VFO	59
PF 4	38	Microphone programmable function key	MONI/ ENTER/ 1750/ VFO/ MR/ CALL/ MHZ/ REV/ SQL/ M--V/ M.IN/ C.IN/ MENU/ SHIFT/ LOW/ BRIGHT/ LOCK/ TONE/ STEP	CALL	59
DT	39	Data TX speed	1200/ 9600 bps	1200	58
BRIGHT	40	Display brightness	—	Maximum level	57
ABR	41	Automatic display brightness	ON/ OFF	OFF	57
WXA <sup>2</sup>	42	Weather Alert	ON/ OFF	OFF	36
RESET	99	Reset selection	VFO/ FULL	VFO	67

<sup>1</sup> TXP (Transmission power) cannot be adjusted on M4 market models. It is fixed at “H” (High: 25 W).

<sup>2</sup> WXA (Weather Alert) is available only for K market models.

# OPERATING THROUGH REPEATERS

Repeaters, which are often installed and maintained by radio clubs, are usually located on mountain tops or other elevated locations. They generally operate at higher ERP (Effective Radiated Power) than a typical station. This combination of elevation and high ERP allows communications over much greater distances than communicating without using repeaters.

Most repeaters use a receive and transmit frequency pair with a standard or non-standard offset (odd-split). In addition, some repeaters must receive a tone from the transceiver to be accessed. For details, consult your local repeater reference.

6

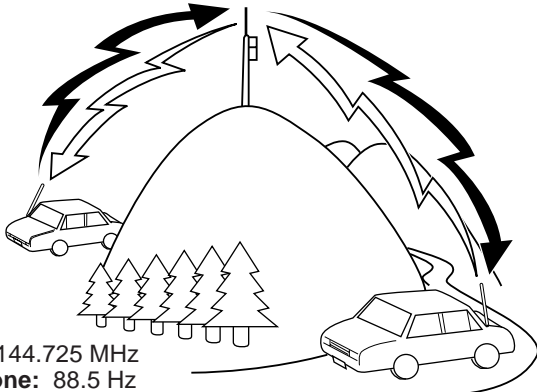

**TX:** 144.725 MHz  
**TX tone:** 88.5 Hz  
**RX:** 145.325 MHz

**TX:** 144.725 MHz  
**TX tone:** 88.5 Hz  
**RX:** 145.325 MHz

## OFFSET PROGRAMMING FLOW

- 1 Select a receive frequency.
- 2 Select an offset direction.
- 3 Select an offset frequency (only when programming odd-split repeater frequencies).
- 4 Activate the Tone function (if necessary).
- 5 Select a tone frequency (if necessary).

If you store all the above data in a Memory Channel, you will not need to reprogram the parameters every time. Refer to “MEMORY CHANNELS” {page 28}.

## PROGRAMMING AN OFFSET

You must first select an amateur radio repeater downlink frequency as described in “SELECTING AN OFFSET FREQUENCY”.

### SELECTING AN OFFSET DIRECTION

Select whether the transmit frequency will be higher (+) or lower (–) than the receive frequency.

- 1 Press **[F]**, **[MENU]** and turn the **Tuning** control to select Menu No. 5 (SFT).
- 2 Press **[MENU]** and turn the **Tuning** control to select “+” or “–”.
- 3 Press **[MENU]** to store the setting or any other key to cancel.
- 4 Press any key other than **[MENU]** to exit Menu Mode.
  - “+” or “–” appears above the frequency, indicating which offset direction is selected.

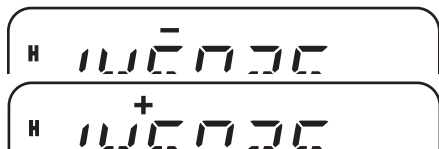

If the offset transmit frequency falls outside the allowable range, transmission is inhibited. In this case, adjust the reception frequency so that the transmit frequency is within the band limits or change the offset direction.

---

**Note:** While using an odd-split memory channel or transmitting, you cannot change the offset direction.

---

## SELECTING AN OFFSET FREQUENCY

To access a repeater which requires an odd-split frequency pair, change the offset frequency from the default which is used by most repeaters. The default offset frequency is 600 kHz.

- 1 Press **[F]**, **[MENU]** and turn the **Tuning** control to select Menu No. 10 (OFFSET).
- 2 Press **[MENU]** and turn the **Tuning** control to select the appropriate offset frequency.



- The selectable range is from 0.00 MHz to 69.95 MHz in steps of 50 kHz.
- 3 Press **[MENU]** to store the setting or any other key to cancel.
  - 4 Press any key other than **[MENU]** to exit Menu Mode.

---

**Note:** After changing the offset frequency, the new offset frequency will also be used by Automatic Repeater Offset.

---

## ACTIVATING THE TONE FUNCTION

To activate Tone, press [F], [CALL].

- As you press [F], [CALL], the selection cycles as follows: “OFF” → “TONE” → “CTCSS” → “DCS” → “OFF”.
- “T” appears on the upper part of display, indicating that the Tone function is activated.



6

**Note:** You cannot use the Tone function and CTCSS/ DCS functions simultaneously. Switching the Tone function ON after having activated the CTCSS/ DCS functions deactivates the CTCSS/ DCS functions.

**E market version only:** When you access repeaters that require a 1750 Hz tone, you do not need to activate the Tone function. Simply press [CALL] without pressing Mic [PTT] to transmit a 1750 Hz tone (default setting).

## SELECTING A TONE FREQUENCY

- 1 Press [F], [MENU] and turn the **Tuning** control to select Menu No. 2 (T).
- 2 Press [MENU] and turn the **Tuning** control to select the desired tone frequency (default is 88.5 Hz).



- 3 Press [MENU] to store the setting or any other key to cancel.
- 4 Press any key other than [MENU] to exit Menu Mode.

## Available Tone Frequencies

42 Tone Frequencies (Hz)					
67.0	85.4	107.2	136.5	173.8	218.1
69.3	88.5	110.9	141.3	179.9	225.7
71.9	91.5	114.8	146.2	186.2	229.1
74.4	94.8	118.8	151.4	192.8	233.6
77.0	97.4	123.0	156.7	203.5	241.8
79.7	100.0	127.3	162.2	206.5	250.3
82.5	103.5	131.8	167.9	210.7	254.1

**Note:** 42 different tones are available for the transceiver. These 42 tones includes 37 EIA standard tones and 5 non-standard tones.

### E market version only:

- ◆ To transmit a 1750 Hz tone, simply press [CALL] without pressing Mic [PTT] (default setting). Release [CALL] to quit transmitting. You can also make the transceiver remain in the transmit mode for 2 seconds after releasing [CALL]; a 1750 Hz tone is not continuously transmitted. Access Menu No. 20 (HLD) and select “ON”.
- ◆ To use [CALL] for recalling the Call Channel in place of transmitting a 1750 Hz tone, access Menu No. 19 (CK) and select “CALL”.

## AUTOMATIC REPEATER OFFSET

This function automatically selects an offset direction, according to the frequency on the VHF band. The transceiver is programmed for an offset direction as shown below. To obtain an up-to-date band plan for repeater offset direction, contact your national Amateur Radio association.

### K market version only

144.0 145.5 146.4 147.0 147.6  
145.1 146.0 146.6 147.4 148.0 MHz

S	-	S	+	S	-	+	S	-
---	---	---	---	---	---	---	---	---

S: Simplex

*This complies with the standard ARRL band plan.*

### E market version only

144.0 145.6 145.8 146.0 MHz

S	-	S
---	---	---

S: Simplex

---

**Note:** Automatic Repeater Offset does not function when the Reverse function is ON. However, pressing **[REV]** after Automatic Repeater Offset has selected an offset (split) status, exchanges the receive and transmit frequencies.

---

- 1 Press **[F]**, **[MENU]** and turn the **Tuning** control to select Menu No. 11 (ARO).
- 2 Press **[MENU]** and turn the **Tuning** control to switch the function "ON" (default) or "OFF".
- 3 Press **[MENU]** to store the setting or any other key to cancel.
- 4 Press any key other than **[MENU]** to exit Menu Mode.

## TRANSMITTING A 1750 Hz TONE

Call Channel default settings:

- On E market models, pressing **[CALL]** causes the transceiver to transmit a 1750 Hz tone.
- On K and M market models, pressing **[CALL]** changes the transceiver to the Call Channel {page 35}.

Most of the repeaters in Europe require the transceiver to transmit a 1750 Hz tone.

To change the setting of the **CALL** key:

- 1 Press **[F]**, **[MENU]** and turn the **Tuning** control to select Menu No. 19 (CK).
- 2 Press **[MENU]** and turn the **Tuning** control to select "CALL" or "1750".
- 3 Press **[MENU]** to store the setting or any other key to cancel.
- 4 Press any key other than **[MENU]** to exit Menu Mode.

Some repeaters in Europe must receive continuous signals for a certain period of time, following a 1750 Hz tone. This transceiver is also capable of remaining in the transmit mode for 2 seconds after transmitting the tone.

- 1 Press **[F]**, **[MENU]** and turn the **Tuning** control to select Menu No. 20 (HLD).
- 2 Press **[MENU]** and turn the **Tuning** control to select "ON" or "OFF" (default).
- 3 Press **[MENU]** to store the setting or any other key to cancel.
- 4 Press any key other than **[MENU]** to exit Menu Mode.

## REVERSE FUNCTION

The reverse function exchanges a separate reception and transmission frequency. So, while using a repeater, you can manually check the strength of a signal that you receive directly from the other station. If the station's signal is strong, both stations should move to a simplex frequency and free up the repeater.

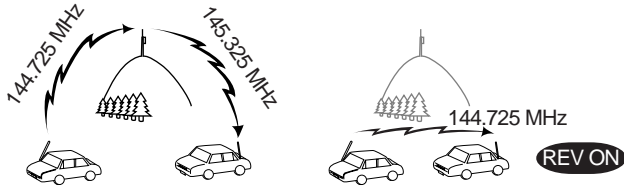

TX: 144.725 MHz TX: 144.725 MHz TX: 144.725 MHz TX: 145.325 MHz  
RX: 145.325 MHz RX: 145.325 MHz RX: 145.325 MHz RX: 144.725 MHz

To swap the transmission and reception frequencies:

Press **[REV]** to switch the Reverse function ON (or OFF).

- “R” appears when the function is ON.

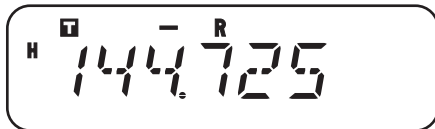

### Note:

- ◆ You can turn the Reverse function ON when you are operating in Simplex Mode. However, it does not change the Transmission/Reception frequencies.
- ◆ If pressing **[REV]** places the reception frequency outside the allowable range, an error tone sounds and the function does not operate.
- ◆ If pressing **[REV]** places the transmission frequency outside the allowable range, pressing Mic **[PTT]** causes an error tone to sound and transmission is inhibited.
- ◆ You cannot switch Reverse ON or OFF while transmitting.

## AUTOMATIC SIMPLEX CHECK (ASC)

While using a repeater, the ASC function periodically checks the strength of the signal you are receiving from the other station. If the station's signal is strong enough to allow direct contact without a repeater, the “**R**” indicator starts blinking.

Press **[REV]** (1s) to switch the function ON (or OFF).

- “**R**” appears when the function is ON.
- While direct contact is possible, “**R**” blinks.





---

**Note:**

- ◆ Pressing **[PTT]** causes the “**R**” icon to quit blinking.
  - ◆ ASC can be activated while operating in Simplex Mode. However, it does not change the Transmission/Reception frequencies.
  - ◆ ASC does not function while scanning.
  - ◆ Activating ASC while using Reverse switches Reverse OFF.
  - ◆ If you recall a Memory Channel or the Call Channel that contains a Reverse ON status, ASC is switched OFF.
  - ◆ ASC causes received audio to be momentarily intermitted every 3 seconds.
- 

## TONE FREQUENCY ID SCAN

This function scans through all tone frequencies to identify the incoming tone frequency on a received signal. You can use this function to determine which tone frequency is required by accessing your local repeater.

- 1 Press **[F]**, **[MENU]** and turn the **Tuning** control to select Menu No. 2 (T).
- 2 Press **[MENU]** (1s) to start the Tone Frequency ID Scan.



- When the transceiver receives a signal, scan starts. The decimal point blinks during scan.
- While the transceiver is receiving a signal during Tone Frequency ID Scan, the signal is emitted from the speaker.
- To reverse the scan direction, turn the **Tuning** control.

- To quit the function, press any key.
- When the tone frequency is identified, a beep sounds and the identified frequency blinks.



- 3 Press **[MENU]** to program the identified tone frequency in place of the current tone frequency or press any other key to exit the Tone Frequency ID Scan.
  - Turn the **Tuning** control while the identified tone frequency is blinking to resume scanning.
- 4 Press any key other than **[MENU]** to exit Menu Mode.

---

**Note:**

- ◆ Some repeaters do not re-transmit the access tone in the download signal. In this case, check the other station's uplink signal to detect the repeater access tone.
  - ◆ The transceiver continues to check the Weather Alert Channel and Priority Channel during Tone Frequency ID Scan.
-

# MEMORY CHANNELS

In Memory Channels, you can store frequencies and related data that you frequently use so that you do not need to reprogram that data every time. You can quickly recall a programmed channel through simple operation. A total of 200 Memory Channels (100 when using the Memory Name function) are available for storing frequencies, modes, and other operating conditions.

## NUMBER OF MEMORY CHANNELS

The transceiver must be configured to either 200 Memory Channels without using the Memory Name function or 100 Memory Channels with the Memory Name function (default).

7

To change the Memory Channel capacity:

- 1 Press **[F]**, **[MENU]** and turn the **Tuning** control to select Menu No. 15 (M.CH).
- 2 Press **[MENU]** and turn the **Tuning** control to select either "100" (default) or "200".



- 3 Press **[MENU]**.
  - "SURE ?" appears.

- 4 Press **[MENU]** to accept or press any other key to cancel.

---

### Note:

- ◆ If you change the Memory Channel capacity from 200 channels to 100 channels after having stored data in channels 100 to 199, all Memory Channel data in channels 100 to 199 will be erased.
  - ◆ If you change the Memory Channel capacity from 100 channels to 200 channels after storing Memory Names in those channels, the Memory Name data will be erased.
- 

## SIMPLEX & REPEATER OR ODD-SPLIT MEMORY CHANNEL?

You can use each Memory Channel as a simplex & repeater channel or an odd-split channel. Store only 1 frequency to use as a simplex & repeater channel or 2 separate frequencies to use as an odd-split channel. Select either application for each channel depending on the operations you have in mind.

Simplex & repeater channels allow:

- Simplex frequency operation
- Repeater operation with a standard offset (if an offset direction is stored)

Odd-split channels allow:

- Repeater operation with a non-standard offset

---

**Note:** Not only can you store data in Memory Channels, but you can also overwrite existing data with new data.

---

The data listed below can be stored in each Memory Channel:

Parameter	Simplex & Repeater	Odd-Split
Receive frequency	Yes	Yes
Transmit frequency		Yes
Tone frequency	Yes	Yes
Tone ON	Yes	Yes
CTCSS frequency	Yes	Yes
CTCSS ON	Yes	Yes
DCS code	Yes	Yes
DCS ON	Yes	Yes
Offset direction	Yes	N/A
Offset frequency	Yes	N/A
Reverse ON	Yes	N/A
Frequency step size	Yes	Yes
Narrow band FM	Yes	Yes
Beat Shift	Yes	Yes
Memory Channel lockout	Yes	Yes
Memory Channel name	Yes	Yes

Yes: Can be stored in memory.

N/A: Cannot be stored in memory.

**Note:**

- ◆ Memory Channel Lockout cannot be set to the Program Scan Memory (L0/U0 ~ L2/U2), the Priority Channel (Pr), or the Weather Alert Channel (AL).
- ◆ Tone, CTCSS, and DCS are automatically turned OFF when setting up the Weather Alert Channel (AL).

## STORING SIMPLEX FREQUENCIES OR STANDARD REPEATER FREQUENCIES

- 1 Press **[VFO]**.
- 2 Turn the **Tuning** control to select your desired frequency.
  - You can also directly enter a desired frequency using the keypad {page 13}.
- 3 If storing a standard repeater frequency, select the following data:
  - Offset direction {page 23}
  - Tone function, if necessary {page 24}
  - CTCSS/ DCS function, if necessary {pages 46, 48}

If storing a simplex frequency, you may select other related data (CTCSS or DCS settings, etc.).
- 4 Press **[F]**.
  - A Memory Channel number appears and blinks.
  - “▲” appears if the channel contains data.



- Memory Channel numbers L0/U0 ~ L2/U2 {page 40}, Pr {page 43}, and AL (Weather Alert) {page 36} (K market models only) are reserved for other functions.

- 5 Turn the **Tuning** control or press Mic **[UP]/[DWN]** to select the Memory Channel in which you want to store the data.
- 6 Press **[MR]** to store the data to the channel.

## STORING ODD-SPLIT REPEATER FREQUENCIES

Some repeaters use a pair of reception and transmission frequencies with a non-standard offset. If you store 2 separate frequencies in a Memory Channel, you can operate on those repeaters without programming the offset frequency and direction.

- 1 Store the desired reception frequency and related data by following steps 1 to 6 given for simplex or standard repeater frequencies {page 29}.
- 2 Turn the **Tuning** control or press Mic **[UP]/[DWN]** to select your desired transmission frequency.
- 3 Press **[F]**.
- 4 Turn the **Tuning** control or press Mic **[UP]/[DWN]** to select the pre-programmed reception Memory Channel in which you want to store the data.
- 5 Press **[MR] (1s)**.
  - The transmission frequency is stored in the Memory Channel.



### Note:

- ◆ When you recall an odd-split Memory Channel, “+” and “-” appear on the display. To confirm the transmission frequency, press **[REV]**.
- ◆ Transmit offset status and reverse status are not stored in odd-split Memory Channels.

## RECALLING A MEMORY CHANNEL

### USING THE TUNING CONTROL

- 1 Press **[MR]** to enter Memory Recall mode.
  - The Memory Channel last used is recalled.
- 2 Turn the **Tuning** control to select your desired Memory Channel.

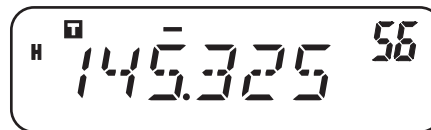

- You cannot recall an empty Memory Channel.
- To restore VFO mode, press **[VFO]**.

## USING THE MICROPHONE KEYPAD

You can also recall a Memory Channel by entering a desired Memory Channel number with the microphone keypad.

- 1 Press **[MR]** to enter Memory Recall mode.
- 2 Press the microphone key assigned the ENTER function.
- 3 Enter the channel number using the microphone keypad.
  - For single-digit channel numbers, enter “0” first or press Mic **Enter** after entering the channel number.
  - For two-digit channel numbers that begin with “1”, press Mic **Enter** after entering the channel number.

---

### Note:

- ◆ You cannot recall an empty Memory Channel. An error beep sounds.
  - ◆ You cannot recall the Program Scan Memory Channels (L0/U0 ~ L2/U2), the Priority Channel (Pr), and the Weather Alert Channel (AL) (K market models only) using the numeric keypad.
  - ◆ When you recall an odd-split memory channel, “+” and “-” appear on the display. Press **[REV]** to display the transmission frequency.
  - ◆ After recalling a Memory Channel, you may modify data such as Narrow Band, Tone, or CTCSS. However, these settings are cleared once you select another channel or the VFO Mode. To permanently store the data, overwrite the channel contents.
- 

## CLEARING A MEMORY CHANNEL

To erase an individual Memory Channel:

- 1 Recall the Memory Channel you want to erase.
- 2 Press [**⏻**] (Power) (**1s**) to switch the transceiver OFF.
- 3 Press **[MR]+[⏻]** (Power).
  - An erase confirmation message appears.

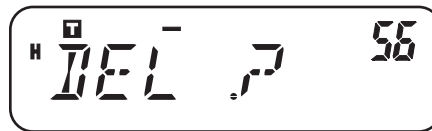

- 4 Press **[MR]** to erase the channel data.
  - The contents of the Memory Channel are erased.
  - To quit clearing the Memory Channel, press any key other than **[MR]**.

---

### Note:

- ◆ You can also clear the Priority Channel, the AL Channel, and L0/U0 ~ L2/U2 data. (The Call Channel cannot be cleared.)
  - ◆ To clear all Memory Channel contents at once, perform Full Reset (page 67).
  - ◆ You cannot clear channels while in Channel Display Mode.
-

## NAMING A MEMORY CHANNEL

You can name Memory Channels using up to 6 alphanumeric characters. When you recall a named Memory Channel, its name appears on the display in place of the stored frequency. Names can be call signs, repeater names, cities, names of people, etc. In order to use the Memory Name function, the Memory Channel capacity must be set to 100 channels. To change the Memory Channel capacity from 200 to 100, access Menu No. 15 (M.CH) {page 28}.

- 1 Press **[MR]** and turn the **Tuning** control to recall your desired Memory Channel.
- 2 Press **[F]**, **[MENU]** and turn the **Tuning** control to select Menu No. 16 (M.NAME).
- 3 Press **[MENU]**.
  - A blinking cursor appears.



- 4 Turn the **Tuning** control to select a desired alphanumeric character.
  - You can enter the following alphanumeric characters: 0 ~ 9, A ~ Z, - (hyphen), / (slash), and a space.
  - Rather than using the **Tuning** control, you can use the Mic keypad (keypad models only) to enter alphanumeric characters {page 64}.

- 5 Press **[MR]**.

- The cursor moves to the next digit.

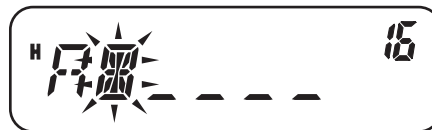

- To move to the previous digit, press **[VFO]**. To delete the character at the current cursor position, press **[F]**.

- 6 Repeat steps 4 and 5 to enter up to 6 digits.

- 7 Press **[MENU]** to complete the entry.

- Press any key other than **[MR]**, **[VFO]**, **[F]**, and **[MENU]** to cancel the entry.
- To complete an entry of less than 6 characters, press **[MENU]** two times.

- 8 Press any key other than **[MENU]** to exit Menu Mode.

After storing a Memory Name, the Memory Name appears in place of the operating frequency. However, you can still display the operating frequency, if desired. To display the frequency rather than Memory Name, access Menu No. 17 (MDF) and select "FRQ". This menu toggles the display mode between the Memory Name ("MN") and frequency display ("FRQ").

---

### Note:

- ◆ You cannot name the Call Channel {page 35}.
  - ◆ You cannot assign a Memory Name to a channel that does not contain data.
  - ◆ You can overwrite stored names by repeating steps 1 to 8.
  - ◆ The stored name is erased when you clear the Memory Channel data.
-

## MEMORY CHANNEL TRANSFER

### MEMORY ➔ VFO TRANSFER

After retrieving frequencies and associated data from Memory Recall Mode, you can copy the data to the VFO. This function is useful, for example, when the frequency you want to monitor is near the frequency stored in a Memory Channel.

- 1 Press **[MR]**, then turn the **Tuning** control or press Mic **[UP]/[DWN]** to recall the desired Memory Channel.
  - Alternatively, press **[CALL]** to select the Call Channel.
- 2 Press **[F]**, **[VFO]** to copy the Memory Channel data to the VFO.

---

#### Note:

- ◆ On odd-split channels, the above operation copies only the reception frequency to the VFO (not the transmission frequency). To copy the transmit frequency of an odd-split channel, press **[REV]** before performing the transfer.
  - ◆ You can also transfer the Program Scan memory channels (L0/U0 ~ L2/U2), the Priority Channel (Pr), and the Weather Alert Channel (AL) (K market models only) to the VFO.
  - ◆ Lockout status and Memory Names are not copied from a Memory Channel to the VFO.
- 

### CHANNEL ➔ CHANNEL TRANSFER

You can copy channel information from one Memory Channel to another. This function is useful when storing frequencies and associated data that you temporarily change in Memory Recall Mode.

- 1 Press **[MR]**, then turn the **Tuning** control or press Mic **[UP]/[DWN]** to recall the desired Memory Channel.
- 2 Press **[F]**.



- 3 Select the Memory Channel where you would like the data copied by using the **Tuning** control or pressing Mic **[UP]/[DWN]**.



- 4 Press **[MR]**.

The tables below illustrate how data is transferred between Memory Channels.

Channel 0 ~ 199	➔	Channel 0 ~ 199
Receive frequency	➔	Receive frequency
Transmit frequency	➔	Transmit frequency
Tone frequency	➔	Tone frequency
Offset direction	➔	Offset direction
CTCSS frequency	➔	CTCSS frequency
DCS code	➔	DCS code
Tone/ CTCSS/ DCS ON/ OFF status	➔	Tone/ CTCSS/ DCS ON/ OFF status
Offset frequency	➔	Offset frequency
Reverse ON	➔	Reverse ON
Frequency step size	➔	Frequency step size
Memory Channel name <sup>1</sup>	➔	Memory Channel name <sup>1</sup>
Memory Channel Lockout ON/ OFF	➔	Memory Channel Lockout ON/ OFF
Narrow FM ON/ OFF	➔	Narrow FM ON/ OFF

Channel 0 ~ 199	➔	L0/U0 ~ L2/U2, Pr, AL <sup>2</sup>
Receive frequency	➔	Receive frequency
Transmit frequency	➔	Transmit frequency
Tone frequency	➔	Tone frequency
Offset direction	➔	Offset direction
CTCSS frequency	➔	CTCSS frequency
DCS code	➔	DCS code
Tone/ CTCSS/ DCS ON/ OFF status	➔	Tone/ CTCSS/ DCS ON/ OFF status
Offset frequency	➔	Offset frequency
Reverse ON	➔	Reverse ON
Frequency step size	➔	Frequency step size
Memory Channel name <sup>1</sup>	➔	Memory Channel name <sup>1</sup>
Memory Channel Lockout ON	➔	Memory Channel Lockout OFF
Narrow FM ON/ OFF	➔	Narrow FM ON/ OFF

<sup>1</sup> When "100" is selected in Menu No.15 (M.CH).

<sup>2</sup> The AL Channel is available for K market models only.

**Note:**

- ◆ When transferring an odd-split channel, the Reverse status, Offset direction, and Offset frequency are not transferred (pages 23, 26).
- ◆ Tone, CTCSS, and DCS are automatically turned OFF when transferring data to the Weather Alert Channel (AL).



## CALL CHANNEL

Call Channel default settings:

- On K and M market models, pressing **[CALL]** changes the transceiver to the Call Channel.
- On E market models, pressing **[CALL]** causes the transceiver to transmit a 1750 Hz tone {page 25}.

The Call Channel can be recalled instantly no matter what frequency the transceiver is operating on. For instance, you may use the Call Channel as an emergency channel within your group. In this case, Call Scan {page 43} will be useful.

The default Call Channel frequency is 144.000 MHz.

---

**Note:** Unlike Memory Channels 0 to 199, the Call Channel cannot be cleared.

---

## RECALLING THE CALL CHANNEL

1 Press **[CALL]** to recall the Call Channel.

- The Call Channel frequency and “C” appear.



- To return to the previous frequency, press **[CALL]** again.

## REPROGRAMMING THE CALL CHANNEL

- 1 Select your desired frequency and related data (Tone, CTCSS, DCS, or offset direction, etc.).
  - When you program the Call Channel as an odd-split channel, select a reception frequency first.
- 2 Press **[F]**.
  - A Memory Channel number appears and blinks.
- 3 Turn the **Tuning** control or press Mic **[UP]/[DWN]** to select the Call Channel (“C”).
- 4 Press **[MR]**.
  - The selected frequency and related data are stored in the Call Channel.



*To also store a separate transmit frequency, continue with the following steps:*

- 5 Select the desired transmission frequency.
- 6 Press **[F]**.
- 7 Turn the **Tuning** control or press Mic **[UP]/[DWN]** to select the Call Channel (“C”).
- 8 Press **[MR] (1s)**.
  - The separate transmission frequency is stored in the Call Channel.

---

**Note:**

- ◆ When you recall an odd-split Call Channel, “+” and “-” appear on the display.
  - ◆ Transmit offset status and Reverse status are not stored in an odd-split Call Channel.
- 

## WEATHER ALERT (K MARKET MODELS ONLY)

Any of the NOAA Weather Radio channels can be programmed to the AL memory channel of the transceiver. The transceiver can be configured to check the NOAA Weather Alert tone (1050 Hz) and will automatically alert you by recalling and monitoring the Weather Radio frequency when the Weather Alert tone is broadcasted, and the “WX” icon will blink.

### 7 PROGRAMMING THE WEATHER RADIO FREQUENCY

The transceiver is preprogrammed to 162.550 MHz (WX1). You can store a different frequency to the AL channel to use this function. Refer to the NOAA channel frequency directory for your local weather channel frequency before you use the Weather Alert function. The latest Weather Radio information can be obtained from <http://www.nws.noaa.gov/nwr/>.

- 1 Press **[VFO]**.
- 2 Select your local NOAA Weather Radio channel frequency using the **Tuning** control or Mic **[UP]/[DWN]**.
- 3 Press **[F]**.
  - A Memory Channel number appears and blinks.

- 4 Turn the **Tuning** control or press Mic **[UP]/[DWN]** to select the Alert Channel (“AL”).
- 5 Press **[MR]**.

Weather Radio Frequencies (MHz)						
WX1	WX2	WX3	WX4	WX5	WX6	WX7
162.550	162.400	162.475	162.425	162.450	162.500	162.525

---

**Note:**

- ◆ When you perform Full Reset {page 63}, the Weather Radio frequency recovers the factory default frequency (162.550 MHz).
  - ◆ When you clear the Weather Radio (AL) Channel {page 31} (the same as clearing a Memory Channel), the factory default frequency (162.550 MHz) will not be recovered.
  - ◆ The Weather Radio (AL) Channel can be programmed with a Channel Name {page 32}.
  - ◆ You can also transfer the AL Memory Channel data to the VFO or another Memory Channel.
- 

## ENABLING A WEATHER ALERT

You can monitor the Weather Radio frequency continuously or in the background while receiving on another frequency.

To monitor the Weather Radio frequency continuously:

- 1 Press **[F]**, **[MENU]** and turn the **Tuning** control to select Menu No. 42 (WXA).
- 2 Press **[MENU]** and turn the **Tuning** control to select “ON” or “OFF” (default).
- 3 Press **[MENU]** to store the setting.
  - “WX” appears on the display.



- 4 Press any key other than **[MENU]** to exit Menu Mode.
  - The transceiver automatically changes to the AL channel.
  - The Tone, CTCSS, and DCS functions cannot be configured to the AL channel.
  - Priority Scan is set to OFF automatically when the Weather Alert function is turned ON.
- 5 To exit Weather Alert Mode, press **[MENU]**, select Menu No. 42 (WXA), and set it to "OFF" (default).

To monitor another frequency while monitoring the Weather Radio in the background:

- 1 Perform step 1 ~ 4, above.
- 2 Press **[VFO]** or **[MR]** and turn the **Tuning** control to select another frequency or Memory Channel.
  - "WX" remains on the LCD.
- 3 When the Weather Alert tone is broadcasted, the transceiver automatically switches to the AL channel.
  - "WX" blinks.
- 4 To exit Weather Alert Mode, press **[MENU]**, select Menu No. 42 (WXA), and set it to "OFF".

---

**Note:**

- ◆ The transceiver checks the Weather Alert tone once every second while you are monitoring another frequency or channel.
  - ◆ When a 1050 Hz tone is detected, the display will change to the AL channel, the Weather Alert tone sounds, and the "WX" icon blinks. Squelch remains open until the frequency is changed or the transceiver power is turned OFF.
  - ◆ If the transceiver is transmitting or receiving a signal on another frequency, the Weather Alert function temporarily pauses.
  - ◆ Turning the Beep function "OFF" does not disable the Weather Alert tone.
  - ◆ You cannot transmit on the AL channel while the Weather Alert function is ON.
- 

## CHANNEL DISPLAY

While in this mode, the transceiver displays only Memory Channel numbers (or Memory Names if they have been stored), instead of frequencies.

- 1 With the transceiver power OFF, press **[REV]+[ ⏪ ]** (Power) to turn the power ON.
  - The transceiver displays the Memory Channel numbers in place of the operating frequencies.



- 2 Turn the **Tuning** control or press Mic **[UP]/[DWN]** to select your desired Memory Channel number.

While in Channel Display mode, you cannot activate the following functions:

- VFO Mode
- VFO Scan
- Call/VFO Scan
- MHz Scan
- Scan Direction
- Memory Store
- Memory to VFO Transfer
- Memory to Memory Transfer
- Clear Memory Channel
- VFO Reset
- Full Reset
- 1 MHz Step
- Selection for Tone and Selective Call
- Auto Simplex Checker
- Menu Mode

To recover normal operation, turn the transceiver power OFF and press **[REV]+[ϕ]** (Power) again.

---

**Note:**

- ◆ To enter the Channel Display Mode, you must have at least one Memory Channel that contains data.
  - ◆ If the Memory Channel contains a Memory Name, the Memory Name is displayed in place of "CH".
-

# SCAN

Scan is a useful function for hands-off monitoring of your favorite frequencies. By becoming comfortable with all types of scan, you will increase your operating efficiency.

This transceiver provides the following types of scans.

Scan Type		Purpose
Normal Scan	Band Scan	Scans the entire band of the frequency you selected.
	Program Scan	Scans the specified frequency ranges stored in Memory Channels L0/U0 ~ L2/U2.
	MHz Scan	Scans the frequencies within a 1 MHz range.
Memory Scan	All-Channel Scan	Scans all Memory Channels from 0 to 199 (or from 0 to 99).
	Group Scan	Scans Memory Channels in groups of 20 channels (0 ~ 19, 20 ~ 39, 40 ~ 59, etc.).
Call Scan	VFO	Scans the Call Channel and the current VFO frequency.
	Memory Channel	Scans the Call Channel and the selected Memory Channel.
Priority Scan		Checks the activities on the Priority Channel (Pr) every 3 seconds.

## Note:

- ◆ When the CTCSS or DCS function is activated, the transceiver stops at a busy frequency and decodes the CTCSS tone or DCS code. If the tone or code matches, the transceiver unmutes. Otherwise, it resumes scanning.
- ◆ Press and hold the Mic PF key programmed as MONI {page 59} to pause scan in order to monitor the scanning frequency. Release the key to resume scanning.
- ◆ Pressing and holding Mic **[PTT]** causes scan to stop (excluding Priority Scan).
- ◆ While scanning, you can change the scan frequency direction by turning the **Tuning** control or using the Mic **[UP]/[DWN]** keys.
- ◆ Starting scan switches OFF the Automatic Simplex Check (ASC) {page 26}.
- ◆ Adjust the Squelch level before using Scan {page 14}. Selecting a Squelch level too low could cause Scan to stop immediately.

## NORMAL SCAN

When you are operating the transceiver in VFO Mode, 3 types of scanning are available: Band Scan, Program Scan, and MHz Scan.

### BAND SCAN

The transceiver scans the entire band of the frequency you selected. For example, if you are operating and receiving at 144.525 MHz, it scans all the frequencies available for the VHF band. (Refer to receiver VFO frequency range in the specifications {page 72}.) When the current VFO receive frequency is outside the Program Scan frequency range {below}, the transceiver scans the entire frequency range available for the current VFO.

- 1 Press **[VFO]** and turn the **Tuning** control or press Mic **[UP]/[DWN]** to select a frequency outside of the Program Scan frequency range.
- 2 Press **[VFO] (1s)** to start Band Scan.
  - Scan starts from the current frequency.
  - The 1 MHz decimal blinks while scanning is in progress.
- 3 Press any key other than **[F]** or **[⏻]** (Power) to stop Band Scan.

---

#### Note:

- ◆ The transceiver scans the frequency range that is stored in Menu No. 7 (P.VFO) {page 61}.
  - ◆ If you select a frequency within the L0/U0 ~ L2/U2 range in step 2, Program Scan starts.
- 

## PROGRAM SCAN

You can limit the scanning frequency range. There are 3 memory channel pairs (L0/U0 ~ L2/U2) available for specifying the start and end frequencies. Program Scan monitors the range between the start and end frequencies that you have stored in these Memory Channels. Before performing Program Scan, store the Program Scan frequency range to one of the Memory Channel pairs (L0/U0 ~ L2/U2).

### ■ Storing a Program Scan Frequency Range

- 1 Press **[VFO]** and turn the **Tuning** control or press Mic **[UP]/[DWN]** to select your desired start frequency.
- 2 Press **[F]**.
  - A Memory Channel number appears and blinks.
- 3 Turn the **Tuning** control or press Mic **[UP]/[DWN]** to select a Memory Channel from L0 ~ L2.



- 4 Press **[MR]** to store the start frequency in the Memory Channel.
- 5 Turn the **Tuning** control to select your desired end frequency.
- 6 Press **[F]**.

7 Turn the **Tuning** control or press Mic **[UP]/[DWN]** to select a matching Memory Channel from U0 ~ U2.

- For example, if you have selected “L0” in step 3, select Memory Channel “U0”.



8 Press **[MR]** to store the end frequency in the Memory Channel.

### ■ Performing Program Scan

1 Press **[VFO]** and turn the **Tuning** control to select a frequency within the frequency range of Memory Channel L0/U0 ~ L2/U2.

2 Press **[VFO] (1s)** to start Program Scan.

- Scan starts from the current frequency.
- The 1 MHz decimal blinks while scanning is in progress.

3 Press any key other than **[F]** or **[ϕ]** (Power) to stop Program Scan.

---

#### Note:

- ◆ The transceiver stops scanning when it detects a signal.
  - ◆ If more than 2 Program Scan channel pairs are stored and overlaps the frequency range among the pairs, the smaller Program Scan Memory Channel number has priority.
  - ◆ If the step size of the current VFO frequency is different from that of the programmed frequencies, VFO Scan begins instead of Program Scan.
  - ◆ To perform Program Scan, the “L” channel must be lower than the “U” channel. Otherwise, Band Scan starts (page 40).
- 

### MHz SCAN

MHz Scan allows you to scan an entire 1 MHz frequency range within the current VFO frequency.

1 Press **[VFO]** and turn the **Tuning** control or press Mic **[UP]/[DWN]** to select a frequency in which to perform MHz Scan.

- If you want to scan the entire 145 MHz frequency, select any frequency between 145.000 and 145.9975 MHz (for example, select 145.650 MHz). Scan will operate between 145.000 MHz and 145.9975 MHz. (The upper frequency limit depends on the current frequency step size.)

2 Press **[MENU] (1s)** to start MHz Scan.

- Scan starts from the current frequency.
- The 1 MHz decimal blinks while scanning is in progress.



3 Press any key other than **[F]** or **[ϕ]** (Power) to stop MHz Scan.

## MEMORY SCAN

Memory Scan monitors Memory Channels in which you have stored frequencies.

### ALL-CHANNEL SCAN

The transceiver scans all of the Memory Channels in which you have stored frequencies.

#### 1 Press **[MR]** (1s).

- Scan starts from the last Memory Channel number and ascends up through the channel numbers (default).
- To jump to a desired channel while scanning, quickly turn the **Tuning** control.
- To reverse the scan direction, turn the **Tuning** control or press Mic **[UP]/[DWN]**.

#### 2 Press any key other than **[F]** or **[ ⏻ ]** (Power) to stop All-Channel Scan.

---

#### Note:

- ◆ You must have 2 or more Memory Channels that contain data, excluding special function Memory Channels (L0/U0 ~ L3/U3, Pr, and AL).
  - ◆ You can perform Memory Scan while in CH Display Mode. While Scan is paused, the Channel number blinks.
- 

### GROUP SCAN

The transceiver scans Memory Channels in groups of 20 channels. When Menu No. 15 (M.CH) is set to 100, the transceiver uses 5 groups of 20 channels. When Menu No. 15 (M.CH) is set to 200, the transceiver uses 10 groups of 20 channels.

1 Press **[MR]** and turn the **Tuning** control or press Mic **[UP]/[DWN]** to select a Memory Channel in the range of the group you want to scan.

#### 2 Press **[MENU]** (1s).

- Scan starts from the selected Memory Channel number and ascends up through the channel numbers (default).
- To reverse the scan direction, turn the **Tuning** control or press Mic **[UP]/[DWN]**.

#### 3 Press any key other than **[F]** or **[ ⏻ ]** (Power) to stop Group Scan.

---

**Note:** You must have 2 or more Memory Channels in the selected group that contain data.

---

100 Channels	200 Channels
Group 1: 0 ~ 19	Group 1: 0 ~ 19
	Group 2: 20 ~ 39
Group 2: 20 ~ 39	Group 3: 40 ~ 59
	Group 4: 60 ~ 79
Group 3: 40 ~ 59	Group 5: 80 ~ 99
	Group 6: 100 ~ 119
Group 4: 60 ~ 79	Group 7: 120 ~ 139
	Group 8: 140 ~ 159
Group 5: 80 ~ 99	Group 9: 160 ~ 179
	Group 10: 180 ~ 199



## CALL SCAN

You can alternate between monitoring the Call Channel and the current operating frequency.

- 1 Select the frequency (in VFO or Memory Recall Mode) you want to monitor.
  - In VFO Mode, turn the **Tuning** control or press Mic **[UP]/[DWN]** to select the desired frequency.
  - In Memory Recall Mode, turn the **Tuning** control or press Mic **[UP]/[DWN]** to select the Memory Channel you want to monitor.
- 2 Press **[CALL] (1s)** to start the Call Scan.
  - The Call Channel and the selected VFO frequency or memory channel are monitored.
  - The 1 MHz decimal blinks while scanning is in progress.
- 3 Press any key other than **[F]** or **[⏻]** (Power) to stop Call Scan.

---

### Note:

- ◆ You must configure the CALL key function to “CALL” (Menu No. 19) prior to using Call Scan. Otherwise, a 1750 Hz tone will be transmitted.
  - ◆ You can perform Call Scan even if the recalled Memory Channel has been locked out (page 44).
- 

## PRIORITY SCAN

You may sometimes want to check your favorite frequency activities while monitoring other frequencies. In this case, use the Priority Scan function. Priority Scan checks the activities of the Priority Channel every 3 seconds. If the transceiver detects a signal on the Priority Channel, it recalls the frequency to the VFO.

### PROGRAMMING A PRIORITY CHANNEL

- 1 Press **[VFO]** and turn the **Tuning** control or press Mic **[UP]/[DWN]** to select your desired Priority Channel frequency.
- 2 Select selective call functions, if necessary.
- 3 Press **[F]**.
  - The Memory Channel number appears and blinks.
- 4 Turn the **Tuning** control or press Mic **[UP]/[DWN]** to select the Priority Channel (“Pr”).



- 5 Press **[MR]** to store the data on the Priority Channel.

## USING PRIORITY SCAN

- 1 Press **[F]**, **[MENU]** and turn the **Tuning** control to select Menu No. 12 (PRI).
- 2 Press **[MENU]** and turn the **Tuning** control to select “ON” or “OFF” (default).
- 3 Press **[MENU]** to store the setting or any other key to cancel.
  - “PRI” appears.

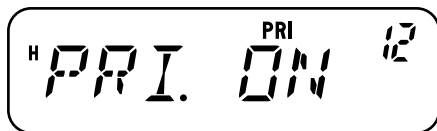

- 4 Press any key other than **[MENU]** to exit Menu Mode.
  - The transceiver checks for a signal on the Priority Channel every 3 seconds.
  - When the transceiver detects a signal on the Priority Channel, “Pr” blinks and the frequency changes to the Priority Channel.
  - If you do not operate any control or key for 3 seconds after the signal drops, the transceiver returns to the original frequency and resumes Priority Scan.

---

### Note:

- ◆ If you clear the Priority Channel {page 31}, Priority Scan stops.
  - ◆ Priority Scan temporarily stops while the transceiver is transmitting.
  - ◆ If Priority Scan is set to ON, the Weather Alert function is automatically turned OFF.
- 

## MEMORY CHANNEL LOCKOUT

You can lock out Memory Channels that you prefer not to monitor during Memory Scan or Group Scan {page 42}.

- 1 Press **[MR]** and turn the **Tuning** control or press Mic **[UP]/[DWN]** to select the Memory Channel to be locked out.
- 2 Press **[F]**, **[MENU]** and turn the **Tuning** control to select Menu No. 14 (L.OUT).
- 3 Press **[MENU]** and turn the **Tuning** control to select “ON” or “OFF” (default).



Memory Channel Number

- 4 Press **[MENU]** to store the setting or any other key to cancel.
- 5 Press any key other than **[MENU]** to exit Menu Mode.
  - The “★” icon appears below the Memory Channel number, indicating the channel is locked out.
- 6 To unlock the Memory Channel, repeat steps 1 ~ 5, selecting “OFF” in step 3.
  - The “★” icon disappears.

---

### Note:

- ◆ The Program Scan channels (L0/U0 ~ L2/U2), Call Channel, Priority Channel (Pr), and Weather Radio Channel (AL) (K market models only) cannot be locked out.
  - ◆ Even if a Memory Channel is locked out, you can perform Call Scan {page 43} between the Call Channel and Memory Channel.
-

## SCAN RESUME METHOD

The transceiver stops scanning at the frequency (or Memory Channel) where a signal is detected. It then continues or stops scanning according to which Resume Mode you have selected.

- **Time-Operated Mode (default)**

The transceiver remains on a busy frequency (or Memory Channel) for approximately 5 seconds, then continues to scan even if the signal is still present.

- **Carrier-Operated Mode**

The transceiver remains on a busy frequency (or Memory Channel) until the signal drops out. There is a 2-second delay between signal dropout and scan resumption.

- **Seek Mode**

The transceiver moves to a frequency (or Memory Channel) where a signal is present and stops.

To change the scan resume method:

- 1 Press **[F]**, **[MENU]** and turn the **Tuning** control to select Menu No. 13 (SCAN).
- 2 Press **[MENU]** and turn the **Tuning** control to select "TO" (Time-Operated; default), "CO" (Carrier-Operated), or "SE" (Seek) Mode.



- 3 Press **[MENU]** to store the new setting or any other key to cancel.

- 4 Press any key other than **[MENU]** to exit Menu Mode.

---

**Note:** To temporarily stop scanning and monitor weak signals, press the Mic PF key assigned the MONI function (page 59). Press the MONI key again to resume scanning.

---

# SELECTIVE CALL

## CTCSS AND DCS

You may sometimes want to hear calls from only specific persons or groups. In this case, use Selective Call. This transceiver is equipped with CTCSS (Continuous Tone Coded Squelch System) and DCS (Digital Coded Squelch). These Selective Calls allow you to ignore (not hear) unwanted calls from other persons who are using the same frequency. The transceiver unmutes only when it receives a signal having the same CTCSS tone or DCS code.

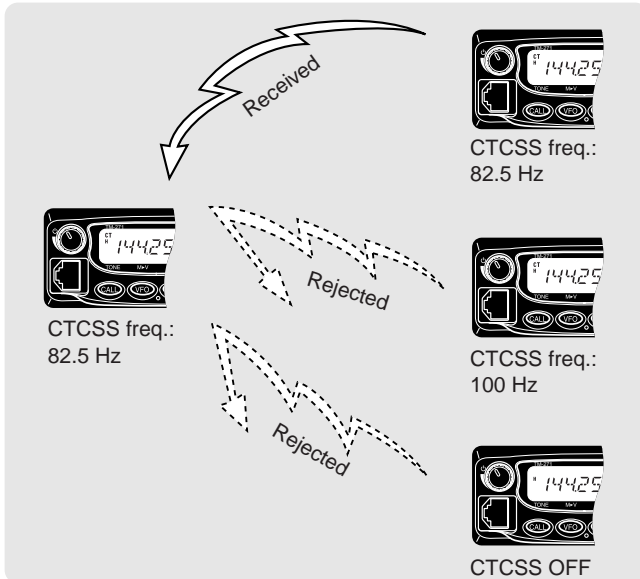

---

**Note:** CTCSS and DCS do not cause your conversation to be private or scrambled. It only relieves you from listening to unwanted conversations.

---

## CTCSS

A CTCSS tone is a sub-audible tone and is selectable from among the 42 tone frequencies listed in the table on page 47. The list includes 37 EIA standard tones and 5 non-standard tones.

To activate CTCSS, press **[F]**, **[CALL]**.

- As you press **[F]**, **[CALL]**, the selection cycles as follows: “OFF” → “TONE” → “CTCSS” → “DCS” → “OFF”.
- “CT” appears on the upper part of display, indicating that the CTCSS function is activated.

When CTCSS is ON, you will hear calls only when the selected CTCSS tone is received. To answer the call, press and hold Mic **[PTT]**, then speak into the microphone.

---

### Note:

- ◆ You cannot use the CTCSS and Tone/ DCS functions simultaneously. Switching the CTCSS function ON after having activated the Tone/ DCS functions deactivates the Tone/ DCS functions.
  - ◆ If you select a high CTCSS frequency, receiving audio or noise that contains the same frequency portions may cause CTCSS to function incorrectly. To prevent noise from causing this problem, select an appropriate squelch level {page 14}.
  - ◆ While transmitting the 1750 Hz tone by pressing **[CALL]** {page 25}, the transceiver does not transmit the CTCSS tone.
-

## SELECTING A CTCSS FREQUENCY

- 1 Press **[F]**, **[MENU]** and turn the **Tuning** control or press Mic **[UP]/[DWN]** to select Menu No. 3 (CT).
  - The current CTCSS frequency appears.
- 2 Press **[MENU]** and turn the **Tuning** control to select your desired CTCSS frequency.
  - The selectable CTCSS frequencies are the same as those for the Tone frequency. Refer to the table below for the available CTCSS frequencies.

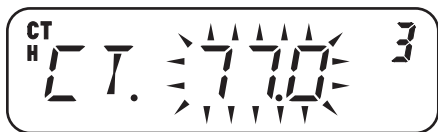

- 3 Press **[MENU]** to store the new setting or any other key to cancel.
- 4 Press any key other than **[MENU]** to exit Menu Mode.

---

**Note:** To use the selected CTCSS tone, you must first turn the CTCSS function ON.

---

## Available CTCSS Tone Frequencies

42 Tone Frequencies (Hz)					
67.0	85.4	107.2	136.5	173.8	218.1
69.3	88.5	110.9	141.3	179.9	225.7
71.9	91.5	114.8	146.2	186.2	229.1
74.4	94.8	118.8	151.4	192.8	233.6
77.0	97.4	123.0	156.7	203.5	241.8
79.7	100.0	127.3	162.2	206.5	250.3
82.5	103.5	131.8	167.9	210.7	254.1

## CTCSS FREQUENCY ID SCAN

This function scans through all CTCSS frequencies to identify the incoming CTCSS frequency on the received signal. You may find this useful when you cannot recall the CTCSS frequency that the other persons in your group are using.

- 1 Press **[F]**, **[MENU]** and turn the **Tuning** control to select Menu No. 3 (CT).
- 2 Press **[MENU]** (1s) to start the CTCSS Frequency ID Scan.



- While scanning, the decimal point of the CTCSS frequency blinks.
- To reverse the scan direction, turn the **Tuning** control or press Mic **[UP]/[DWN]**.
- To quit the function, press any key.
- When a CTCSS frequency is identified, the identified frequency appears and blinks.



- 3 Press **[MENU]** to program the identified frequency in place of the current CTCSS frequency or press any other key to exit the CTCSS Frequency ID Scan.
  - Turn the **Tuning** control or press Mic **[UP]/[DWN]** while the identified frequency is blinking to resume scanning.
- 4 Press any key other than **[MENU]** to exit Menu Mode.

9

**Note:**

- ◆ CTCSS turns ON automatically when performing CTCSS Frequency ID Scan, even if the current frequency is not set with CTCSS.
- ◆ Received signals are monitored through the speaker while scanning is in progress.
- ◆ The transceiver continues to check the Weather Alert Channel and Priority Channel during CTCSS scanning.
- ◆ CTCSS Frequency ID Scan does not scan the tone if a signal is not detected.

## DCS

DCS is similar to CTCSS. However, instead of using an analog audio tone, it uses a continuous sub-audible digital waveform that represents a 3-digit octal number. You can select a DCS code from among the 104 DCS codes listed in the table below.

To activate DCS, press **[F]**, **[CALL]**.

- As you press **[F]**, **[CALL]**, the selection cycles as follows: “OFF” → “TONE” → “CTCSS” → “DCS” → “OFF”.
- “DCS” appears on the upper part of display, indicating that the DCS function is activated.

When DCS is ON, you will hear calls only when the selected DCS code is received. To answer the call, press and hold Mic **[PTT]**, then speak into the microphone.

---

**Note:** You cannot use the DCS function and CTCSS/ Tone functions simultaneously. Switching the DCS function ON after having activated the CTCSS/ Tone functions deactivates the CTCSS/ Tone functions.

---

## SELECTING A DCS CODE

- 1 Press **[F]**, **[MENU]** and turn the **Tuning** control to select Menu No. 4 (DCS).
  - The current DCS code appears.
- 2 Press **[MENU]** and turn the **Tuning** control to select your desired DCS code.
  - The current DCS code appears and blinks.



- The available DCS codes are shown in the following table.

104 DCS Codes									
023	065	132	205	255	331	413	465	612	731
025	071	134	212	261	332	423	466	624	732
026	072	143	223	263	343	431	503	627	734
031	073	145	225	265	346	432	506	631	743
032	074	152	226	266	351	445	516	632	754
036	114	155	243	271	356	446	523	654	
043	115	156	244	274	364	452	526	662	
047	116	162	245	306	365	454	532	664	
051	122	165	246	311	371	455	546	703	
053	125	172	251	315	411	462	565	712	
054	131	174	252	325	412	464	606	723	

- 3 Press **[MENU]** to store the new code or any other key to cancel.
- 4 Press any key other than **[MENU]** to exit Menu Mode.

### DCS CODE ID SCAN

This function scans through all DCS codes to identify the incoming DCS code on the received signal. You may find this useful when you cannot recall the DCS code that the other persons in your group are using.

- 1 Press **[F]**, **[MENU]** and turn the **Tuning** control to select Menu No. 4 (DCS).
- 2 Press **[MENU]** (1s) to start the DCS Code ID Scan function.



- While scanning, the decimal point between “DCS” and the DCS code blinks.
- To quit the function, press any key.
- When a DCS code is identified, the identified DCS code appears and blinks.



- 3 Press **[MENU]** to program the identified DCS code in place of the current DCS code or press any other key to exit the DCS Code ID Scan.
  - Turn the **Tuning** control or press Mic **[UP]/[DWN]** while the identified DCS code is blinking to resume scanning.
- 4 Press any key other than **[MENU]** to exit Menu Mode.

#### Note:

- ◆ DCS turns ON automatically when performing DCS Code ID Scan, even if the current frequency is not set with DCS.
- ◆ Received signals are monitored through the speaker while scanning is in progress.
- ◆ The transceiver continues to check the Weather Alert Channel and Priority Channel during DCS scanning.
- ◆ DCS Code ID Scan does not scan the code if a signal is not detected.

# DUAL TONE MULTI-FREQUENCY (DTMF) FUNCTIONS

This transceiver provides you with 10 dedicated DTMF Memory Channels. You can store a DTMF number (16 digits max.) in each of these channels to recall later for speed dialing.

Many repeaters in the U.S.A. and Canada offer a service called Autopatch. You can access the public telephone network via such a repeater by sending DTMF tones. For further information, consult your local repeater reference.

## MANUAL DIALING

The keys on the Mic keypad function as DTMF keys; the 12 keys found on a push-button telephone plus 4 additional keys (A, B, C, D).

To perform Manual Dialing, follow the steps below.

- 1 Press and hold Mic **[PTT]** to transmit.
- 2 While transmitting, press the keys in sequence on the keypad, to send the DTMF tones.
  - The corresponding DTMF tones are transmitted.

Freq. (Hz)	1209	1336	1477	1633
697	1	2	3	A
770	4	5	6	B
852	7	8	9	C
941	*	0	#	D

- When DTMF TX Hold is activated {page 51}, you do not need to continuously press Mic **[PTT]** to remain in transmission mode. However, transmission mode is retained for only 2 seconds after pressing a key, so if the next key is not pressed within this time limit, the transceiver stops transmitting.

## DTMF MONITOR

When pressing the Mic DTMF keys, you will not hear DTMF tones emitted from the speaker. However, you can monitor the DTMF tones if desired.

- 1 Press **[F]**, **[MENU]** and turn the **Tuning** control to select Menu No. 33 (DT.M).
- 2 Press **[MENU]** and turn the **Tuning** control to select "ON" or "OFF" (default).



- 3 Press **[MENU]** to store the setting or any other key to cancel.
- 4 Press any key other than **[MENU]** to exit Menu Mode.



## DTMF TX HOLD

This function causes the transceiver to remain in transmission mode for 2 seconds after you release each key. So, you can release Mic [PTT] while sending DTMF tones.

- 1 Press [F], [MENU] and turn the **Tuning** control to select Menu No. 30 (DT.H).
- 2 Press [MENU] and turn the **Tuning** control to select "ON" or "OFF" (default).



- 3 Press [MENU] to store the setting or any other key to cancel.
- 4 Press any key other than [MENU] to exit Menu Mode.

## AUTOMATIC DIALER

If you use the 10 dedicated DTMF Memory Channels to store DTMF numbers, you do not need to remember a long string of digits.

## STORING A DTMF NUMBER IN MEMORY

- 1 Press [F], [MENU] and turn the **Tuning** control to select Menu No. 28 (DTMF.MR).
- 2 Press [MENU] and turn the **Tuning** control to select your desired DTMF Memory Channel number from 0 to 9.
  - You can also select a DTMF Memory Channel by using Mic [UP]/[DWN].



- 3 Press [MENU].
  - The DTMF code entry display appears and the first digit blinks.
- 4 Turn the **Tuning** control to select a DTMF code.
  - You can also enter a DTMF code using the Mic keypad. Simply press your desired DTMF codes on the keypad.
  - On the display, \* is represented by "E" and # is represented by "F".
- 5 Press [MR] to select the DTMF code and move the cursor to the next digit.

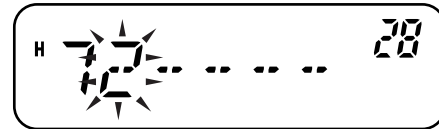

- To move to the previous digit, press [VFO]. To delete the character at the current cursor position, press [F].

- 6 Repeat steps 4 and 5 to enter up to 16 digits.
- 7 Press **[MENU]** to complete the entry.
  - Press any key other than **[MR]**, **[VFO]**, **[F]**, and **[MENU]** to cancel the entry.
  - To complete an entry of less than 16 digits, press **[MENU]** two times.
- 8 Press any key other than **[MENU]** to exit Menu Mode.

### CONFIRMING STORED DTMF NUMBERS

- 1 Press **[F]**, **[MENU]** and turn the **Tuning** control to select Menu No. 28 (DTMF.MR).
- 2 Press **[MENU]** and turn the **Tuning** control to select your desired DTMF Memory Channel number from 0 to 9.
  - You can also select a DTMF Memory Channel by using Mic **[UP]/[DWN]**.
- 3 Press **[REV]**.
  - The numbers scroll across the display and the DTMF tones emit from the speaker without transmitting.
- 4 Press any key other than **[REV]** or **[MENU]** to exit.

### TRANSMITTING A STORED DTMF NUMBER

- 1 Press Mic **[PTT]**+Mic **[PF/D]**.
- 2 Release Mic **[PF/D]** (continue pressing Mic **[PTT]**), then press a key from 0 to 9 to transmit the desired DTMF Memory Channel number.
  - To transmit tone “D”, press Mic **[PF/D]** again.

- The number stored in the channel scrolls across the display, accompanied by DTMF tones from the speaker. (DTMF tones are not emitted if Menu No. 33 (DT.M) is set to “OFF”.)
- After transmission, the frequency display is restored.

### 3 Release Mic **[PTT]**.

---

#### Note:

- ◆ If you select an empty DTMF Memory Channel and press **[MENU]**, the frequency display is restored.
  - ◆ In step 2, above, you can preview the DTMF Memory Channels first by turning the **Tuning** control or pressing Mic **[UP]/[DWN]**.
- 

### ADJUSTING THE DTMF TONE TRANSMISSION SPEED

This transceiver allows you to configure the DTMF number transmission speed between Fast (default) and Slow. If a repeater cannot respond to the fast speed, adjust this parameter.

- 1 Press **[F]**, **[MENU]** and turn the **Tuning** control to select Menu No. 29 (SPD).
- 2 Press **[MENU]** and turn the **Tuning** control to select “FA” (Fast) or “SL” (Slow).
  - The tone duration of Fast is 50 ms and Slow is 100 ms.
- 3 Press **[MENU]** to store the setting or any other key to cancel.

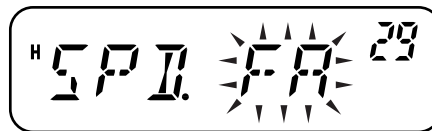

- 4 Press any key other than **[MENU]** to exit Menu Mode.

## ADJUSTING THE PAUSE DURATION

You can change the pause duration (a space digit) stored in Memory Channels. The default setting is 500 milliseconds.

- 1 Press **[F]**, **[MENU]** and turn the **Tuning** control to select Menu No. 31 (PA).
- 2 Press **[MENU]** and turn the **Tuning** control to select 100, 250, 500 (default), 750, 1000, 1500, or 2000 ms.
- 3 Press **[MENU]** to store the setting or any other key to cancel.



- 4 Press any key other than **[MENU]** to exit Menu Mode.

## DTMF LOCK

You sometimes may want to disable the keypad to avoid accidental DTMF transmission. In this case, turn the DTMF Lock function ON.

- 1 Press **[F]**, **[MENU]** and turn the **Tuning** control to select Menu No. 32 (DT.L).
- 2 Press **[MENU]** and turn the **Tuning** control to select "ON" or "OFF" (default).
- 3 Press **[MENU]** to store the setting or any other key to cancel.

- 4 Press any key other than **[MENU]** to exit Menu Mode.

When this function is activated, you cannot send DTMF tones using the Mic keypad. DTMF memory transmission is also inhibited.

# AUXILIARY FUNCTIONS

## APO (AUTO POWER OFF)

The transceiver switches OFF automatically if no keys or controls are pressed or adjusted for the selected duration. One minute before the transceiver switches OFF, warning beeps sound for a few seconds and "APO" blinks.

You can select the APO time from OFF (disable), 30, 60, 90, 120, or 180 minutes.

- 1 Press **[F]**, **[MENU]** and turn the **Tuning** control to select Menu No. 18 (APO).
- 2 Press **[MENU]** and turn the **Tuning** control to select the APO time from OFF (default), 30, 60, 90, 120, or 180 minutes.



- 3 Press **[MENU]** to store the setting or any other key to cancel.
- 4 Press any key other than **[MENU]** to exit Menu Mode.

### Note:

- ◆ APO continues to count even while the transceiver is scanning.
- ◆ The APO timer starts counting down the time when no key presses, no control adjustments, and no PC control command sequences are detected.
- ◆ The APO warning beep sounds even if Menu No. 24 (BP) {page 55} is set to "OFF" or the volume level is 0.

## BEAT SHIFT

Since the transceiver uses a microprocessor to control various functions of the transceiver, the CPU clock oscillator's harmonics or image may appear on some spots of the reception frequencies. In this case, turn the Beat Shift function ON.

- 1 Press **[F]**, **[MENU]** and turn the **Tuning** control to select Menu No. 25 (BS).
- 2 Press **[MENU]** and turn the **Tuning** control to select "ON" or "OFF" (default).

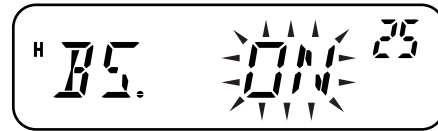

- 3 Press **[MENU]** to store the setting or any other key to cancel.
- 4 Press any key other than **[MENU]** to exit Menu Mode.

## S-METER SQUELCH

S-meter Squelch causes the squelch to open only when a signal with a strength greater than or the same as the S-meter setting is received. This function relieves you from constantly resetting the squelch when receiving weak stations you have no interest in.

- 1 Press **[F]**, **[MENU]** and turn the **Tuning** control to select Menu No. 8 (SSQ).
- 2 Press **[MENU]** and turn the **Tuning** control to select "ON" or "OFF" (default).

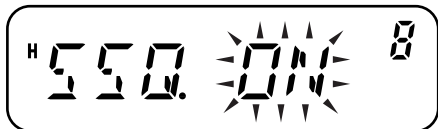

- 3 Press **[MENU]** to store the setting.
  - The S-meter setting segments appear.
- 4 Press any key other than **[MENU]** to exit Menu Mode.



- 5 Press **[F]**, **[REV]** to enter S-Meter Level Select Mode.
- 6 Turn the **Tuning** control to select your desired level.
- 7 Press any key other than **[ϕ]** (Power) to store the setting and exit S-Meter Level Select Mode.

## SQUELCH HANG TIME

When using S-meter Squelch, you may want to adjust the time interval between when the received signals drop and when the squelch closes.

- 1 Press **[F]**, **[MENU]** and turn the **Tuning** control to select Menu No. 9 (SQH).

- 2 Press **[MENU]** and turn the **Tuning** control to select from OFF (default), 125, 250, and 500 ms.



- 3 Press **[MENU]** to store the setting or any other key to cancel.
- 4 Press any key other than **[MENU]** to exit Menu Mode.

## BEEP FUNCTION

The Beep function provides confirmation of entry, error status, and malfunctions of the transceiver. We recommend you leave this function ON in order to detect erroneous operations and malfunctions.

However, to turn the beep function OFF:

- 1 Press **[F]**, **[MENU]** and turn the **Tuning** control to select Menu No. 24 (BP).
- 2 Press **[MENU]** and turn the **Tuning** control to select "OFF".



- 3 Press **[MENU]** to store the setting or any other key to cancel.
- 4 Press any key other than **[MENU]** to exit Menu Mode.

The transceiver generates the following warning beeps even if the Beep function is turned OFF.

- APO warning beeps {page 54}
- Weather Alert beep {page 36}
- Time-out Timer warning beep {page 62}

---

**Note:** The beep output level is linked to the **VOL** control position.

---

## BUSY CHANNEL LOCKOUT

This function is used to prevent transmitting on a channel or frequency that somebody else is currently using. When turned ON, an error beep sounds and you cannot transmit even if you press Mic **[PTT]** while another party is using the channel or frequency.

- 1 Press **[F]**, **[MENU]** and turn the **Tuning** control to select Menu No. 22 (BCL).
- 2 Press **[MENU]** and turn the **Tuning** control to select "ON" or "OFF" (default).

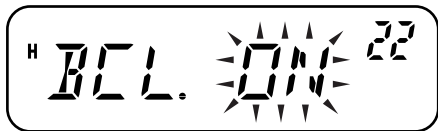

- 3 Press **[MENU]** to store the setting or any other key to cancel.

- 4 Press any key other than **[MENU]** to exit Menu Mode.

## FREQUENCY STEP SIZE

Choosing the correct frequency step size is essential in selecting your exact receive frequency using the **Tuning** control or Mic **[UP]/[DWN]**. You can select your desired frequency step size from:

2.5 kHz, 5 kHz, 6.25 kHz, 10 kHz, 12.5 kHz, 15 kHz, 20 kHz, 25 kHz, 30 kHz, 50 kHz, 100 kHz.

To change the frequency step size:

- 1 While in VFO Mode, press **[F]**, **[MENU]** and turn the **Tuning** control to select Menu No. 1 (STP).
- 2 Press **[MENU]** and turn the **Tuning** control to select your desired frequency step size.



- 3 Press **[MENU]** to store the setting or any other key to cancel.
- 4 Press any key other than **[MENU]** to exit Menu Mode.

---

**Note:** If you change to a frequency step size that does not match the current operating frequency, the transceiver automatically adjusts the frequency to match the new frequency step size.

---

The default step size for each model is as follows:

Market Code	Default Frequency Step Size
K	5 kHz
E	12.5 kHz
M2	12.5 kHz
M3	12.5 kHz

**Note:** The market code is printed on the barcode label of the carton box.

## DISPLAY BACKLIGHT

You can manually change the display brightness to match the lighting conditions where you are operating the transceiver. This setting can be permanent or the display can light up only when keys are pressed.

### PERMANENT BACKLIGHT

When a permanent setting is selected, the backlight will remain at that setting until it is changed again. The default setting is the maximum brightness.

- 1 Press **[F]**, **[MENU]** and turn the **Tuning** control to select Menu No. 40 (BRIGHT).
- 2 Press **[MENU]** and turn the **Tuning** control to adjust the display brightness.



- 3 Press **[MENU]** to store the setting or any other key to cancel.
- 4 Press any key other than **[MENU]** to exit Menu Mode.

**Note:** Setting the brightness to OFF (minimum level 1) will turn the front panel key backlight OFF.

### AUTOMATIC BACKLIGHT

When using automatic backlight, the display backlight will illuminate every time a front panel or microphone key is pressed. The backlight remains on for 5 seconds before it turns off again.

- 1 Press **[F]**, **[MENU]** and turn the **Tuning** control to select Menu No. 41 (ABR).
- 2 Press **[MENU]** and turn the **Tuning** control to select "ON" or "OFF" (default).

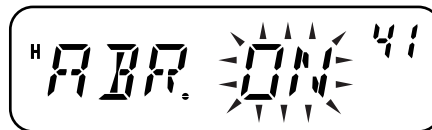

- 3 Press **[MENU]** to store the setting or any other key to cancel.
- 4 Press any key other than **[MENU]** to exit Menu Mode.

**Note:** No change occurs if the brightness is set to the highest level.

## LOCK FUNCTION

The lock function disables most of the keys to prevent you from accidentally activating a function. Transceiver Lock is suitable for a typical mobile installation where you select most operations using the microphone.

### 1 Press **[F]** (1s).

- “**LO**” appears when this function is ON.



- The following keys cannot be locked:  
**[P]** (Power), **[F]** (1s), **[F]+[REV]**, **Volume** control, **[PTT]**, and the Mic keypad.

### 2 Press **[F]** (1s) again to unlock the keys.

#### Note:

- ◆ The **Tuning** control is also locked. To retain use of the **Tuning** control while the Lock function is ON, access Menu No. 27 (ENC) {below} and select “ON”.
- ◆ You cannot reset the transceiver {page 67} while the Lock function is ON.
- ◆ You cannot switch the transceiver operating mode by pressing **[P]** (Power) + any key.
- ◆ Microphone PF keys {page 59} operate normally even if the Lock function is ON.

## DATA COMMUNICATION SPEED

When the transceiver is connected to a TNC {page 7} (E market models only), you can adjust the communication speed between 1200 bps and 9600 bps.

- 1 Press **[F]**, **[MENU]** and turn the **Tuning** control to select Menu No. 39 (DT).
- 2 Press **[MENU]** and turn the **Tuning** control to select “1200” (default) or “9600”.



- 3 Press **[MENU]** to store the setting or any other key to cancel.
- 4 Press any key other than **[MENU]** to exit Menu Mode.

## TUNE ENABLE

While the Lock function is ON, you sometimes may want to turn the **Tuning** control to change the frequency. In this case, turn the Tune Enable function ON.

- 1 Press **[F]**, **[MENU]** and turn the **Tuning** control to select Menu No. 27 (ENC).
- 2 Press **[MENU]** and turn the **Tuning** control to select “OFF” (default) or “ON”.



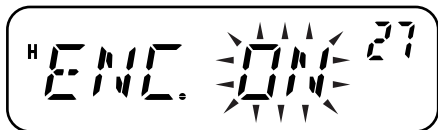

- 3 Press **[MENU]** to store the setting or any other key to cancel.
- 4 Press any key other than **[MENU]** to exit Menu Mode.

### MICROPHONE PF KEYS (KEYPAD MODELS ONLY)

You can access many transceiver settings without using transceiver keys or controls. Microphone keys PF/D, MR/C, VFO/B, and CALL/A are programmable with transceiver functions.

The microphone key default assignments are as follows:

- Mic PF1 key **[PF/D]**: 1 MHz step
- Mic PF2 key **[MR/C]**: Memory Recall
- Mic PF3 key **[VFO/B]**: VFO Select
- Mic PF4 key **[CALL/A]**: Call Channel Select

---

#### Note:

- ◆ Turn the transceiver OFF before connecting the microphone.
  - ◆ Menu No. 34 (MCL) must be configured to "OFF" in order to program the microphone keys.
- 

- 1 Press **[F]**, **[MENU]** and turn the **Tuning** control to select one of Menu No. 35 to Menu No. 38 (PF1 ~ PF4).

- 2 Press **[MENU]** and turn the **Tuning** control to select the programmable function from the list provided below.

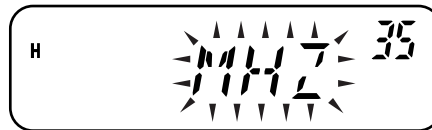

- 3 Press **[MENU]** to store the setting or any other key to cancel.
- 4 Press any key other than **[MENU]** to exit Menu Mode.

### Programmable Functions

- MONI: Monitor function ON/OFF
- ENTER: Used to enter a frequency or memory channel number with the keypad
- 1750: Transmit 1750 Hz
- VFO: Enter VFO Mode
- MR: Enter MR Mode
- CALL: Select the Call Channel
- MHZ: Enter 1 MHz Step Mode
- REV: Reverse function ON/OFF (momentary press) and Auto Simplex Checker function ON/OFF (must be held down for 1 second to activate)
- SQL: Enter Squelch Mode
- M--V: Memory to VFO transfer
- M.IN: Store a Memory Channel
- C.IN: Store the Call Channel
- MENU: Enter Menu Mode

- **SHIFT:** Shift function ON/OFF
- **LOW:** Select transmission power
- **BRIGHT:** Adjust display backlight
- **LOCK:** Transceiver Lock function ON/OFF (must be held down for 1 second to activate)
- **TONE:** Selection for Tone/ Selective Call
- **STEP:** Select the frequency step size

---

**Note:** Rather than entering Menu Mode and selecting PF1 ~ PF4, you can simply press and hold the PF key you want to program, then turn the transceiver power ON. When programming the PF keys in this manner, select the function by turning the **Tuning** control or pressing Mic **[UP]/[DWN]**, press **[MENU]** to store the setting, then press any key other than **[MENU]** to exit Menu Mode.

---

## NARROW BAND FM OPERATION

By default, the transceiver operates in normal FM ( $\pm 5$  kHz) mode for both transmission and reception. You can also operate the transceiver in narrow band FM ( $\pm 2.5$  kHz).

To operate the transceiver in narrow band FM:

- 1 Press **[F]**, **[MENU]** and turn the **Tuning** control to select Menu No. 26 (FMN).
- 2 Press **[MENU]** and turn the **Tuning** control to select "ON" or "OFF" (default).

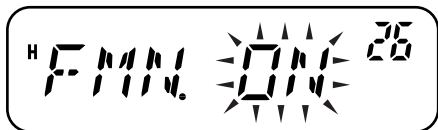

- 3 Press **[MENU]** to store the setting or any other key to cancel.
- 4 Press any key other than **[MENU]** to exit Menu Mode.

When narrow band FM operation is ON, "N" appears in the top right of the LCD.



---

**Note:** You can store the narrow band FM operation status to the Memory Channels (page 29).

---

## POWER-ON MESSAGE

You can change the Power-on message (a maximum of 6 characters) when the transceiver is turned ON.

- 1 Press **[F]**, **[MENU]** and turn the **Tuning** control to select Menu No. 23 (P.ON.MSG).
- 2 Press **[MENU]**.
  - The current message and entry cursor appear.

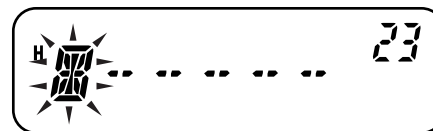

- 3 Turn the **Tuning** control to select a character.
  - You can enter the following alphanumeric characters: 0 ~ 9, A ~ Z, - (hyphen), / (slash), and a space.
  - Rather than using the **Tuning** control, you can use the Mic keypad (keypad models only) to enter alphanumeric characters {page 64}.
- 4 Press **[MR]** to move to the next digit.
  - To move to the previous digit, press **[VFO]**. To delete the character at the current cursor position, press **[F]**.
- 5 Repeat steps 3 and 4 to enter up to 6 digits.

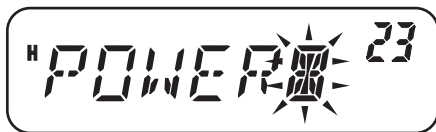

- 6 Press **[MENU]** to complete the setting and store the Power-on message.
- 7 Press any key other than **[MENU]** to exit Menu Mode.

---

**Note:** If a Power-on message is not set, the transceiver model name appears when the transceiver power is turned ON.

---

## PROGRAMMABLE VFO

To limit the operating frequencies within a certain range, program the upper and lower frequency limits to the program VFO parameters. For example, if you select 144 MHz for the lower limit and 145 MHz for the upper limit, the tunable range will be limited from 144.000 MHz to 145.9975 MHz.

- 1 While in VFO mode, press **[F]**, **[MENU]** and turn the **Tuning** control to select Menu No. 7 (P.VFO).
  - The current programmable frequency range for the band appears.
- 2 Press **[MENU]** and turn the **Tuning** control to select the lower limit frequency (in MHz).



- 3 Press **[MENU]** and turn the **Tuning** control to select the upper limit frequency (in MHz).

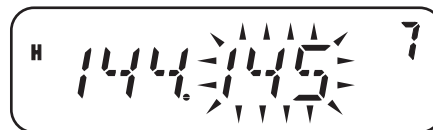

- 4 Press **[MENU]** to store the setting or any other key to cancel.
- 5 Press any key other than **[MENU]** to exit Menu Mode.

---

**Note:**

- ◆ You cannot program the 100 kHz or lower digits.
  - ◆ The upper limit frequency cannot be set lower than the selected lower limit frequency.
-

## TIME-OUT TIMER

The Time-out Timer limits the time of each transmission to a maximum of 3, 5, or 10 (default) minutes. Just before the transceiver stops the transmission, a warning beep sounds. This function is necessary to protect the transceiver from thermal damage and can therefore not be turned OFF.

- 1 Press **[F]**, **[MENU]** and turn the **Tuning** control to select Menu No. 21 (TOT).
- 2 Press **[MENU]** and turn the **Tuning** control to select "3", "5" or "10" (default) minutes.



- 3 Press **[MENU]** to store the setting or any other key to cancel.
- 4 Press any key other than **[MENU]** to exit Menu Mode.

---

**Note:** A warning beep sounds even if you set Menu No. 24 (BP) to OFF {page 55}.

---

## MICROPHONE CONTROL

You can change numerous transceiver settings by operating the Mic DTMF keys.

The following table shows what function is switched ON and OFF or which setting is changed by pressing the DTMF keys in the appropriate mode of operation.

Key	RX Mode	TX Mode <sup>1</sup>	Storing Memory Name	Storing DTMF Memory	Storing Power-on Message
1	N/A	Transmit Tone 1	See note, below	Input Code 1	See note, below
2	N/A	Transmit Tone 2	See note, below	Input Code 2	See note, below
3	N/A	Transmit Tone 3	See note, below	Input Code 3	See note, below
4	N/A	Transmit Tone 4	See note, below	Input Code 4	See note, below
5	N/A	Transmit Tone 5	See note, below	Input Code 5	See note, below
6	N/A	Transmit Tone 6	See note, below	Input Code 6	See note, below
7	N/A	Transmit Tone 7	See note, below	Input Code 7	See note, below
8	N/A	Transmit Tone 8	See note, below	Input Code 8	See note, below
9	N/A	Transmit Tone 9	See note, below	Input Code 9	See note, below
0	N/A	Transmit Tone 0	See note, below	Input Code 0	See note, below
CALL/A	Assigned function	Transmit Tone A	Delete current character	Input Code A	Delete current character
VFO/B	Assigned function	Transmit Tone B	Move cursor to previous digit	Input Code B	Move cursor to previous digit
MR/C	Assigned function	Transmit Tone C	Move cursor to next digit	Input Code C	Move cursor to next digit
PF/D	Assigned function	Transmit Tone D <sup>2</sup>	Confirm Memory Name	Input Code D	Confirm Power-on Message
DWN/✱	Down	Transmit Tone ✱	Move character down	Input Code ✱ <sup>3</sup>	Move character down
UP/ #	Up	Transmit Tone #	Move character up	Input Code # <sup>4</sup>	Move character up

- 1 DTMF tones are not transmitted in TX Mode if the DTMF Lock function is ON.
- 2 When transmitting a stored DTMF number, press Mic [PTT]+Mic [PF/D], release Mic [PF/D], then press a Memory Channel number from 0 to 9. To transmit the “D” tone, press Mic [PF/D] again.
- 3 On the display, ✱ is represented by “E”.
- 4 On the display, # is represented by “F”.

---

**Note:** When storing a Memory Name or Power-on message, the DTMF keys can be used. Each time a key is pressed, the displayed character will change, according to the table below.

---

Key	Displayed Characters			
1	Q	Z	1	
2	A	B	C	2
3	D	E	F	3
4	G	H	I	4
5	J	K	L	5
6	M	N	O	6
7	P	R	S	7
8	T	U	V	8
9	W	X	Y	9
0	[space]	0	—	/

## MIC LOCK

The Mic Lock function disables the Mic PF keys to prevent you from accidentally changing the transceiver operation.

- 1 Press [F], [MENU] and turn the **Tuning** control to select Menu No. 34 (MC.L).
- 2 Press [MENU] and turn the **Tuning** control to select “ON” or “OFF” (default).

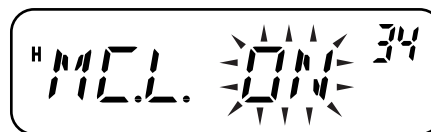

- 3 Press [MENU] to store the setting or any other key to cancel.
- 4 Press any key other than [MENU] to exit Menu Mode.

---

**Note:** The Mic Lock function will not lock the DTMF keys.

---

## OPTIONAL ACCESSORIES

**PS-33/53**  
Regulated DC  
Power Supply



**SP-50B**  
Communications Speaker



**MCP-1A**  
Memory Control Program  
(Free Software)

The MCP-1A can be downloaded at:  
<http://www.kenwood.com/i/products/info/amateur.html>

**PG-2N**  
DC Power Cable



**PG-3B**  
DC Line Noise Filter



**PG-5A**  
Data Cable  
(E market only)



Programming Cable



Ask your dealer about purchasing a Programming Cable.

**KMC-30**  
Microphone



**KMC-32**  
DTMF Microphone



Although the key names differ from those on the supplied DTMF microphone (K, E, M3 market models only), the key functions remain the same.

**MC-60A**  
Stand Microphone  
(MJ-88 required)



**MJ-88**  
Modular to 8-pin  
Microphone Plug



## MAINTENANCE

### GENERAL INFORMATION

This product has been factory aligned and tested to specification before shipment. Under normal circumstances, the transceiver will operate in accordance with these instructions. All adjustable trimmers, coils, and resistors in the transceiver were preset at the factory. They should only be readjusted by a qualified technician who is familiar with this transceiver and has the necessary test equipment. Attempting service or alignment without factory authorization can void the transceiver warranty.

When operated properly, the transceiver will provide years of service and enjoyment without requiring further realignment. The information in this section gives some general service procedures requiring little or no test equipment.

### SERVICE

If it is ever necessary to return this equipment to your dealer or service center for repair, pack it in its original box and packing material. Include a full description of the problems experienced. Include your telephone number, fax number, and e-mail address (if available) along with your name and address in case the service technician needs to call you for further information while investigating your problem. Do not return accessory items unless you feel they are directly related to the service problem.

You may return this product for service to the authorized **KENWOOD** dealer from whom you purchased it, or any authorized **KENWOOD** service center. A copy of the service report will be returned with the transceiver. Please do not send subassemblies or printed circuit boards; send the complete transceiver.

Tag all returned items with your name and call sign for identification. Please mention the model and serial number of the transceiver in any communication regarding the problem.

### SERVICE NOTE

If you desire to correspond on a technical or operational problem, please make your note short, complete, and to the point. Help us help you by providing the following:

- Model and serial number of equipment
- Question or problem you are having
- Other equipment in your station pertaining to the problem
- Meter readings
- Other related information (menu setup, mode, frequency, key sequence to induce malfunction, etc.)



Do not pack the equipment in crushed newspapers for shipment! Extensive damage may result during rough handling or shipping.



---

**Note:**

- ◆ Record the date of purchase, serial number and dealer from whom this product was purchased.
  - ◆ For your own information, retain a written record of any maintenance performed on this product.
  - ◆ When claiming warranty service, please include a photocopy of the bill of sale, or other proof-of-purchase showing the date of sale.
- 

## CLEANING

The keys, controls, and case of the transceiver are likely to become soiled after extended use. Remove the controls from the transceiver and clean them with a neutral detergent and warm water. Use a neutral detergent (no strong chemicals) and a damp cloth to clean the case.

## RESETTING THE TRANSCEIVER

If your transceiver seems to be malfunctioning, resetting the microprocessor may solve the problem. The following 2 reset modes are available. When performing the reset, you may lose memory data and stored information. Back up or write down important data before performing the reset.

### INITIAL SETTINGS

The factory defaults for the operating frequencies are as follows.

- Transceiver: 144.000 MHz

The Memory Channels have no data stored. The Weather Radio frequency (AL channel) is restored as 162.550 MHz (K market models only). Refer to pages 25 and 56 for the Call Channel and frequency step size default values.

---

**Note:** When in Channel Display Mode or while Key Lock is activated (page 58), you cannot perform VFO reset or Full reset.

---

## FULL RESET

This resets all transceiver parameters to the factory default values. There are two methods available for resetting the transceiver.

### Full Reset Method 1:

- 1 With the transceiver power OFF, press **[F]+[ϕ]** (Power).
  - All indicators light momentarily, followed by the full reset confirmation message.

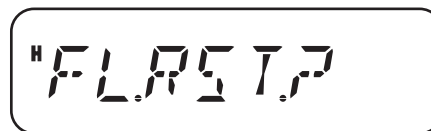

- 2 Press **[F]**.
  - "SURE ?" appears.
  - Press any key other than **[F]** to cancel.
- 3 Press **[F]** again to reset the transceiver.
  - "WAIT" appears momentarily.

## Full Reset Method 2:

- 1 Press **[F]**, **[MENU]** and turn the **Tuning** control to select Menu No. 99 (RESET).
- 2 Press **[MENU]** and turn the **Tuning** control to select "FULL".
- 3 Press **[MENU]**.
  - "SURE ?" appears.



- Press any key other than **[MENU]** to cancel.
- 4 Press **[MENU]** to reset the transceiver.
    - "WAIT" appears momentarily.

## VFO RESET

This resets the transceiver parameters excluding the DTMF Memory, the Memory channel contents, and the Call channel contents. There are two methods available for resetting the transceiver.

---

**Note:** Menu No. 7 (P.VFO) and Menu No. 10 (OFFSET) return to the factory default values.

---

## VFO Reset Method 1:

- 1 With the transceiver power OFF, press **[VFO]+[⏻]** (Power).
  - The VFO reset confirmation message appears.



- 2 Press **[VFO]**.
  - "SURE ?" appears.
  - Press any key other than **[VFO]** to cancel.
- 3 Press **[VFO]** again to reset the transceiver.
  - "WAIT" appears momentarily.

## VFO Reset Method 2:

- 1 Press **[F]**, **[MENU]** and turn the **Tuning** control to select Menu No. 99 (RESET).
- 2 Press **[MENU]** and turn the **Tuning** control to select "VFO".
- 3 Press **[MENU]**.
  - "SURE ?" appears.



- Press any key other than **[MENU]** to cancel.
- 4 Press **[MENU]** to reset the transceiver.

## TROUBLESHOOTING

The problems described in the following tables are commonly encountered operational malfunctions. These types of difficulties are usually caused by improper hook-up, accidental incorrect control settings, or operator error due to incomplete programming. These problems are usually not caused by circuit failure. Please review these tables and the appropriate section(s) of this instruction manual before assuming your transceiver is defective.

Problem	Probable Cause	Corrective Action	Page Ref.
The transceiver will not power up after connecting a 13.8 V DC power supply and pressing the <b>[ϕ]</b> (Power) switch. Nothing appears on the display.	<b>1</b> The power cable was connected backwards.	<b>1</b> Connect the supplied DC power cable correctly: Red → ( + ); Black → ( - ).	3
	<b>2</b> One or more of the power cable fuses are open.	<b>2</b> Look for the cause of the blown fuse(s). After inspecting and correcting any problems, install a new fuse(s) with the same ratings.	5
The display is too dim, even though you selected a high brightness level.	The supply voltage is too low.	The supply voltage requirement is 13.8 V DC ±15% (11.7 V to 15.8 V DC). If the input voltage is outside this range, adjust your regulated power supply and/or check all power cable connections.	3, 4
The frequency cannot be selected by turning the <b>Tuning</b> control or by pressing Mic <b>[UP]/[DOWN]</b> .	Memory Recall was selected.	Press <b>[VFO]</b> .	30, 15
Most buttons/keys and the <b>Tuning</b> control do not function.	<b>1</b> One of the Lock functions is ON.	<b>1</b> Unlock all of the Lock functions.	53,58,64
	<b>2</b> The transceiver is in Channel Display mode.	<b>2</b> With the transceiver power OFF, press <b>[ϕ]</b> (Power)+ <b>[REV]</b> to exit Channel Display mode.	37

Problem	Probable Cause	Corrective Action	Page Ref.
Memory Channels cannot be selected by turning the <b>Tuning</b> control or by pressing Mic <b>[UP]/[DWN]</b> .	No data has been stored in any Memory Channels.	Store data in some Memory Channels.	29
You cannot transmit even though you press Mic <b>[PTT]</b> .	<b>1</b> The microphone plug was not inserted completely into the front panel connector.	<b>1</b> Switch OFF the power, then insert the microphone plug until the locking tab clicks in place.	6
	<b>2</b> You selected a transmit offset that places the transmit frequency outside the allowable transmit frequency range.	<b>2</b> Press <b>[F]</b> , <b>[MENU]</b> and turn the <b>Tuning</b> control to select Menu No. 5 (SFT). Press <b>[MENU]</b> and turn the <b>Tuning</b> control to select "OFF". Press <b>[MENU]</b> to store the setting, then press any key other than <b>[MENU]</b> to exit Menu Mode.	23
	<b>3</b> The external TNC is transmitting.	<b>3</b> Press Mic <b>[PTT]</b> after the TNC has finished transmitting.	—

## SPECIFICATIONS

Specifications are subject to change without notice due to advancements in technology.

General		
TX frequency range	K market models	144 ~ 148 MHz
	E market models	144 ~ 146 MHz
	M2, M3 market models	136 ~ 174 MHz
	M4 market models	144 ~ 148 MHz
RX frequency range	K market models	136 ~ 174 MHz
	E market models	136 ~ 174 MHz
	M2, M3 market models	136 ~ 174 MHz
	M4 market models	144 ~ 148 MHz
Mode		F3E (FM)
Antenna impedance		50 Ω
Usable temperature range		-20°C ~ +60°C (-4°F ~ +140°F)
Power supply		13.8 V DC ±15% (11.7 ~ 15.8 V)
Grounding method		Negative ground
Current	Transmit (max.)	M4 market models: 8 A or less All other market models: 13 A or less
	Receive (at 2 W output)	1.0 A or less
Frequency stability (-20°C ~ +60°C)		Within ±2.5 ppm
Dimensions (W x H x D projections not included)		160 x 43 x 137 mm/ 6 5/16" x 1 11/16" x 5 13/32"
Weight		Approx. 1.2 kg/ 2.6 lb

### Transmitter

Power output	High	M4 market models: 25 W All other market models: 60 W
	Low	Approx. 25 W
Modulation		Reactance
Spurious emissions		-60 dB or less
Maximum frequency deviation		Wide: $\pm 5$ kHz Narrow: $\pm 2.5$ kHz
Audio distortion (at 60% modulation)		3% or less
Microphone impedance		600 $\Omega$

### Receiver

Circuitry	Double conversion superheterodyne
Intermediate frequency (1st/ 2nd)	49.95 MHz/ 450 kHz
Sensitivity (12 dB SINAD)	Wide: 0.18 $\mu\text{V}$ or less Narrow: 0.22 $\mu\text{V}$ or less
Selectivity (-6 dB)	Wide: 12 kHz or more Narrow: 10 kHz or more
Selectivity (-60 dB)	Wide: 30 kHz or less Narrow: 24 kHz or less
Squelch sensitivity	0.1 $\mu\text{V}$ or less
Audio output (8 $\Omega$ , 5% distortion)	2 W or higher
Audio output impedance	8 $\Omega$

# INDEX

1750 Hz .....	25	Confirming a Stored Number .....	52	Lockout .....	44	Reverse Function .....	26
Accessories		Lock .....	53	Naming .....	32	Scan	
Optional .....	65	Manual Dialing .....	50	Recalling .....	30	All-Channel .....	42
Supplied .....	1	Monitor .....	50	Storing, Odd-split .....	30	Band .....	40
All-Channel Scan .....	42	Pause Duration .....	53	Storing, Simplex .....	29	Call .....	43
Automatic Power Off .....	54	Storing in Memory .....	51	Transfer to VFO .....	33	Group .....	42
Automatic Repeater Offset .....	25	Tone Transmission Speed ...	52	Menu		MHz .....	41
Automatic Simplex Check .....	26	Transmitting a Stored Number .....	52	Access .....	18	Priority .....	43
Automatic Dialer .....	51	TX Hold .....	51	Function List .....	19	Program .....	41
Band Scan .....	40	Frequencies, Selecting		MHz Mode .....	16	Resume Method .....	45
Beat Shift .....	54	Direct Frequency Entry .....	16	MHz Scan .....	41	Specifications .....	71
Beep Function .....	55	MHz Mode .....	16	Microphone		Squelch	
Busy Channel Lockout .....	56	VFO Mode .....	15	Control .....	63	Adjusting .....	14
Call Channel		Frequency Step Size .....	56	Lock .....	64	Hang Time .....	55
Changing .....	35	Full Reset .....	67	PF Keys .....	59	S-meter .....	54
Recalling .....	35	Fuses, Replacing .....	5	Narrow Band FM .....	60	Time-out Timer (TOT) .....	62
Call Scan .....	43	Group Scan .....	42	Offset		Tone	
Channel Display .....	37	Installation .....	2	Automatic Repeater .....	25	1750 Hz Tone .....	25
Continuous Tone Coded Squelch System (CTCSS)		Accessory Connections .....	6	Direction .....	23	Activating .....	24
Freq. ID Scan .....	47	Antenna Connection .....	5	Frequency .....	23	Freq. ID Scan .....	27
Selecting a Frequency .....	47	DC Power Cable Connection, Fixed Station .....	4	Power-on Message .....	60	Selecting .....	24
Using .....	46	DC Power Cable Connection, Mobile .....	3	Power ON/ OFF .....	14	Transmitting .....	15
Data Communication		PC Connection .....	6	Priority Scan		Output Power .....	15
Speed .....	58	TNC Connection .....	7	Programming .....	43	Troubleshooting .....	69
Digital Code Squelch (DCS)		Keypad Direct Entry .....	13	Using .....	44	Tuning Control Unlock .....	58
Code ID Scan .....	49	Keys and Controls .....	9	Program Scan		VFO	
Selecting a Code .....	48	Lock Function .....	58	Frequency Range .....	40	Mode .....	15
Using .....	48	Maintenance .....	66	Using .....	41	Programmable .....	61
Display		Manual Dialing .....	50	Programmable Function		Reset .....	68
Backlight .....	57	Memory Channels		(PF) Keys .....	59	Volume, Adjusting .....	14
LCD .....	10	Clearing .....	31	Repeater Operation .....	22	Weather Alert	
Dual Tone Multi-Frequency (DTMF)				Reset		Enabling .....	36
Automatic Dialer .....	51			Full .....	67	Programming .....	36
				VFO .....	68		

KENWOOD

CE 0682 Ⓢ